

Power MOSFET

PRODUCT SUMMARY	
V_{DS} (V)	-50
$R_{DS(on)}$ (Ω)	$V_{GS} = -10$ V 0.28
Q_g max. (nC)	26
Q_{gs} (nC)	6.2
Q_{gd} (nC)	8.6
Configuration	Single

FEATURES

- P-channel versatility
- Compact plastic package
- Fast switching
- Low drive current
- Ease of paralleling
- Excellent temperature stability
- Material categorization: for definitions of compliance please see www.vishay.com/doc?99912



RoHS
COMPLIANT

DESCRIPTION

The power MOSFET technology is the key to Vishay's advanced line of power MOSFET transistors. The efficient geometry and unique processing of the power MOSFET design achieve very low on-state resistance combined with high transconductance and extreme device ruggedness.

The P-channel power MOSFETs are designed for application which require the convenience of reverse polarity operation. They retain all of the features of the more common N-channel power MOSFETs such as voltage control, very fast switching, ease of paralleling, and excellent temperature stability.

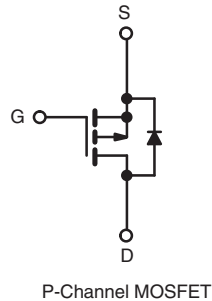
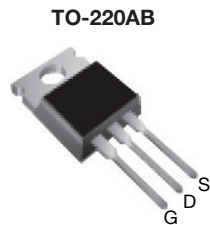
P-channel power MOSFETs are intended for use in power stages where complementary symmetry with N-channel devices offers circuit simplification. They are also very useful in drive stages because of the circuit versatility offered by the reverse polarity connection. Applications include motor control, audio amplifiers, switched mode converters, control circuits and pulse amplifiers.



ORDERING INFORMATION	
Package	TO-220AB
Lead (Pb)-free	IRF9Z20PbF



ABSOLUTE MAXIMUM RATINGS ($T_C = 25^\circ\text{C}$, unless otherwise noted)				
PARAMETER		SYMBOL	LIMIT	UNIT
Drain-Source Voltage		V_{DS}	-50	V
Gate-Source Voltage		V_{GS}	± 20	
Continuous Drain Current	V_{GS} at -10 V	I_D	$T_C = 25^\circ\text{C}$	-9.7
			$T_C = 100^\circ\text{C}$	-6.1
Pulsed Drain Current ^a		I_{DM}	-39	A
Linear Derating Factor			0.32	W/ $^\circ\text{C}$
Inductive Current, Clamped	L = 100 μH	I_{LM}	-39	A
Unclamped Inductive Current (Avalanche current)		I_L	-2.2	A
Maximum Power Dissipation	$T_C = 25^\circ\text{C}$	P_D	40	W
Operating Junction and Storage Temperature Range		T_J, T_{stg}	-55 to +150	$^\circ\text{C}$
Soldering Recommendations (Peak temperature) ^c	for 10 s		300	

Notes

- Repetitive rating; pulse width limited by maximum junction temperature (see fig. 14).
- $V_{DD} = -25$ V, starting $T_J = 25^\circ\text{C}$, L = 100 μH , $R_g = 25 \Omega$
- 0.063" (1.6 mm) from case.

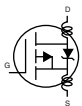

THERMAL RESISTANCE RATINGS				
PARAMETER	SYMBOL	TYP.	MAX.	UNIT
Maximum Junction-to-Ambient	R_{thJA}	-	80	°C/W
Case-to-Sink, Flat, Greased Surface	R_{thCS}	1.0	-	
Maximum Junction-to-Case (Drain)	R_{thJC}	-	3.1	

SPECIFICATIONS ($T_J = 25\text{ }^\circ\text{C}$, unless otherwise noted)							
PARAMETER	SYMBOL	TEST CONDITIONS		MIN.	TYP.	MAX.	UNIT
Static							
Drain-Source Breakdown Voltage	V_{DS}	$V_{GS} = 0\text{ V}, I_D = -250\text{ }\mu\text{A}$		-50	-	-	V
Gate-Source Threshold Voltage	$V_{GS(th)}$	$V_{DS} = V_{GS}, I_D = -250\text{ }\mu\text{A}$		-2.0	-	-4.0	V
Gate-Source Leakage	I_{GSS}	$V_{GS} = \pm 20\text{ V}$		-	-	± 500	nA
Zero Gate Voltage Drain Current	I_{DSS}	$V_{DS} = \text{max. rating}, V_{GS} = 0\text{ V}$		-	-	-250	μA
		$V_{DS} = \text{max. rating} \times 0.8, V_{GS} = 0\text{ V}, T_J = 125\text{ }^\circ\text{C}$		-	-	-1000	
Drain-Source On-State Resistance	$R_{DS(on)}$	$V_{GS} = -10\text{ V}$	$I_D = -5.6\text{ A}^b$	-	0.20	0.28	Ω
Forward Transconductance	g_{fs}	$V_{DS} = 2 \times V_{GS}, I_{DS} = -5.6\text{ A}^b$		2.3	3.5	-	S
Dynamic							
Input Capacitance	C_{iss}	$V_{GS} = 0\text{ V},$ $V_{DS} = -25\text{ V},$ $f = 1.0\text{ MHz, see fig. 9}$		-	480	-	μF
Output Capacitance	C_{oss}			-	320	-	
Reverse Transfer Capacitance	C_{rss}			-	58	-	
Total Gate Charge	Q_g	$V_{GS} = -10\text{ V}$	$I_D = -9.7\text{ A}, V_{DS} = -0.8\text{ max. rating, see fig. 17}$	-	17	26	nC
Gate-Source Charge	Q_{gs}			-	4.1	6.2	
Gate-Drain Charge	Q_{gd}			-	5.7	8.6	
Turn-On Delay Time	$t_{d(on)}$	$V_{DD} = -25\text{ V}, I_D = -9.7\text{ A},$ $R_g = 18\text{ }\Omega, R_D = 2.4\text{ }\Omega,$ see fig. 16 (MOSFET switching times are essentially independent of operating temperature)		-	8.2	12	ns
Rise Time	t_r			-	57	86	
Turn-Off Delay Time	$t_{d(off)}$			-	12	18	
Fall Time	t_f			-	25	38	
Internal Drain Inductance	L_D	Between lead, 6 mm (0.25") from package and center of die contact 		-	4.5	-	nH
Internal Source Inductance	L_S			-	7.5	-	
Drain-Source Body Diode Characteristics							
Continuous Source-Drain Diode Current	I_S	MOSFET symbol showing the integral reverse p - n junction diode 		-	-	-9.7	A
Pulsed Diode Forward Current ^a	I_{SM}			-	-	-39	
Body Diode Voltage	V_{SD}	$T_J = 25\text{ }^\circ\text{C}, I_S = -9.7\text{ A}, V_{GS} = 0\text{ V}^b$		-	-	-6.3	V
Body Diode Reverse Recovery Time	t_{rr}	$T_J = 25\text{ }^\circ\text{C}, I_F = -9.7\text{ A}, di/dt = 100\text{ A}/\mu\text{s}^b$		56	110	280	ns
Body Diode Reverse Recovery Charge	Q_{rr}			0.17	0.34	0.85	μC
Forward Turn-On Time	t_{on}	Intrinsic turn-on time is negligible (turn-on is dominated by L_S and L_D)					

Notes

- a. Repetitive rating; pulse width limited by maximum junction temperature (see fig. 14).
- b. Pulse width $\leq 300\text{ }\mu\text{s}$; duty cycle $\leq 2\%$.

TYPICAL CHARACTERISTICS (25 °C, unless otherwise noted)

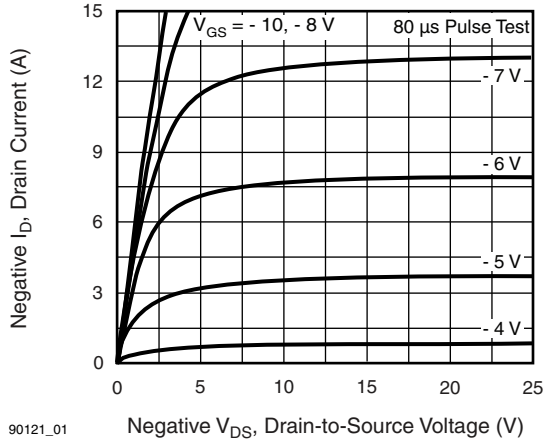

Fig. 1 - Typical Output Characteristics

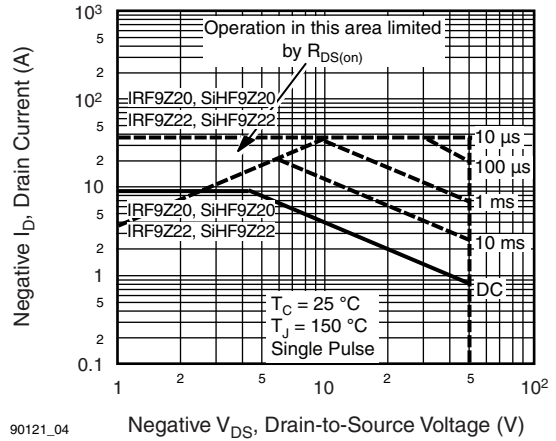

Fig. 4 - Maximum Safe Operating Area

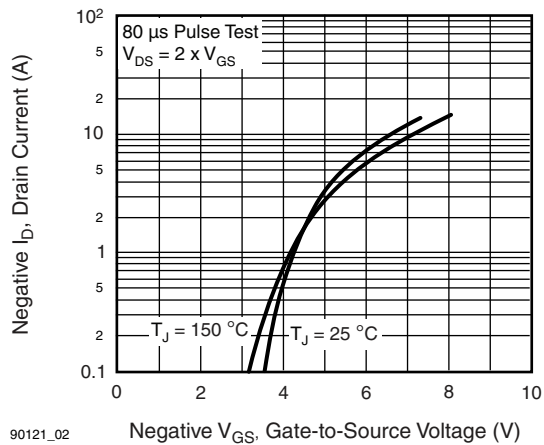

Fig. 2 - Typical Transfer Characteristics

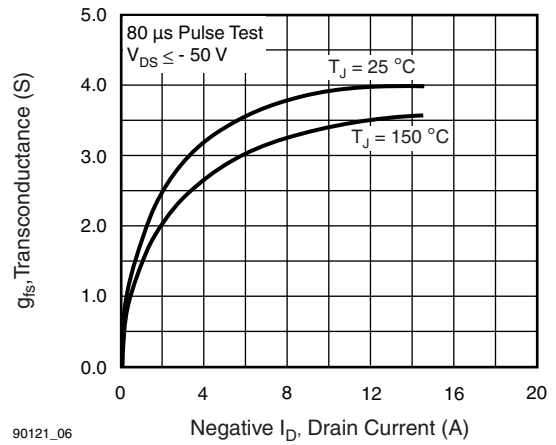

Fig. 5 - Typical Transconductance vs. Drain Current

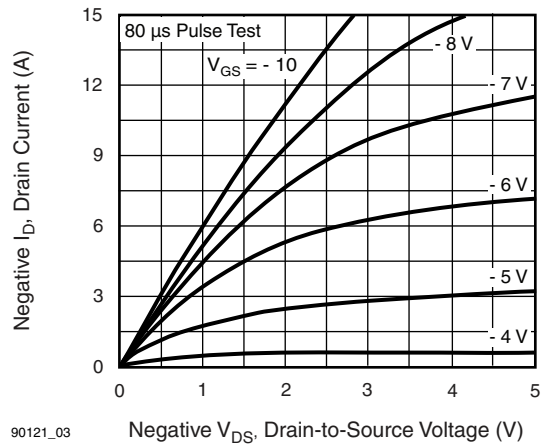

Fig. 3 - Typical Saturation Characteristics

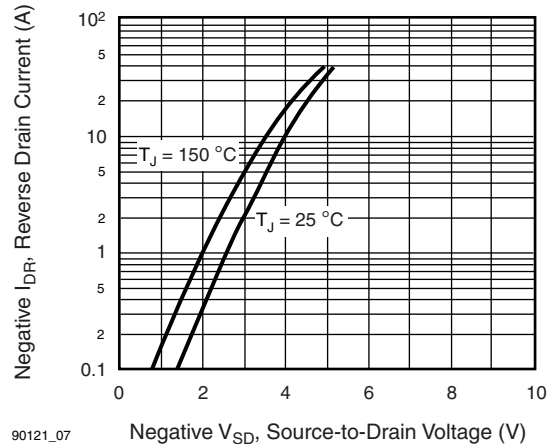

Fig. 6 - Typical Source-Drain Diode Forward Voltage

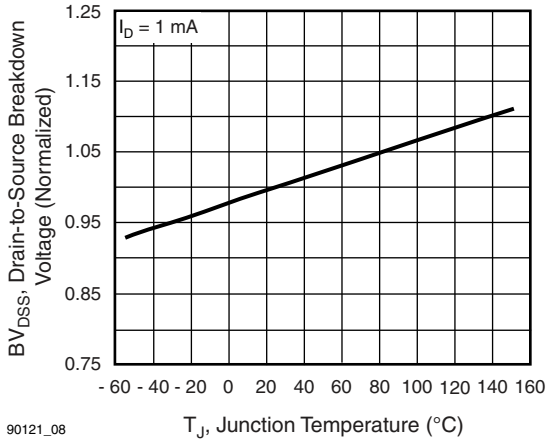

Fig. 7 - Breakdown Voltage vs. Temperature

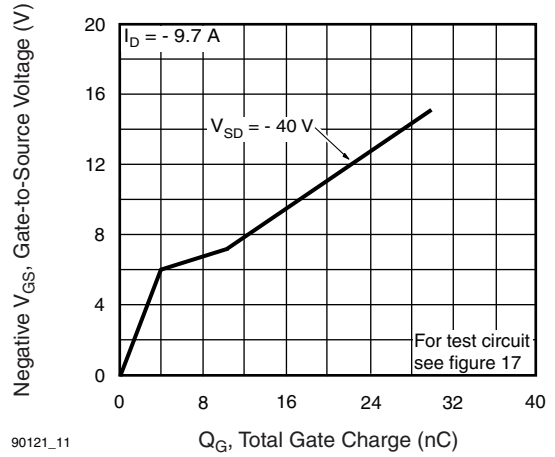

Fig. 10 - Typical Gate Charge vs. Gate-to-Source Voltage

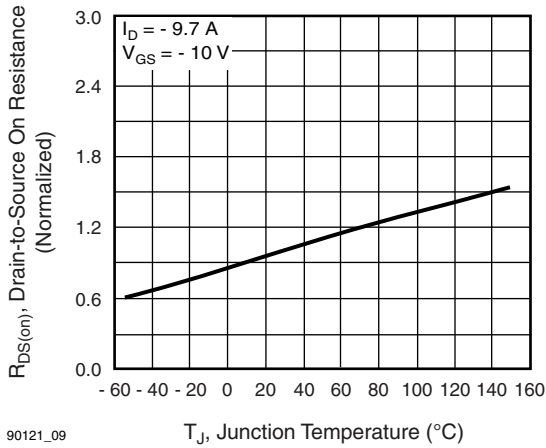

Fig. 8 - Normalized On-Resistance vs. Temperature

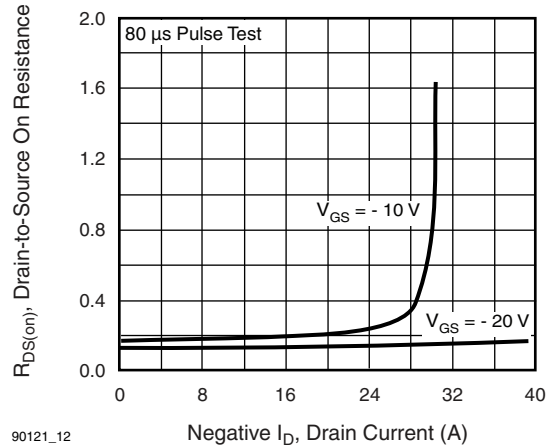

Fig. 11 - Typical On-Resistance vs. Drain Current

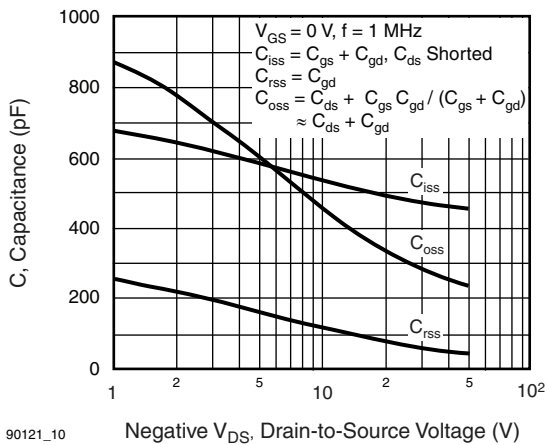

Fig. 9 - Typical Capacitance vs. Drain-to-Source Voltage

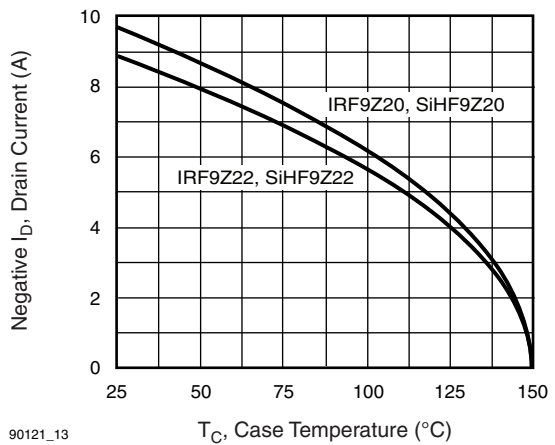

Fig. 12 - Maximum Drain Current vs. Case Temperature

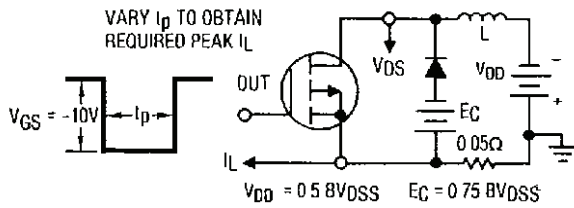

Fig. 13a - Unclamped Inductive Test Circuit

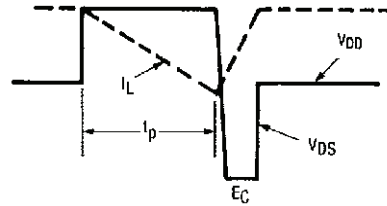
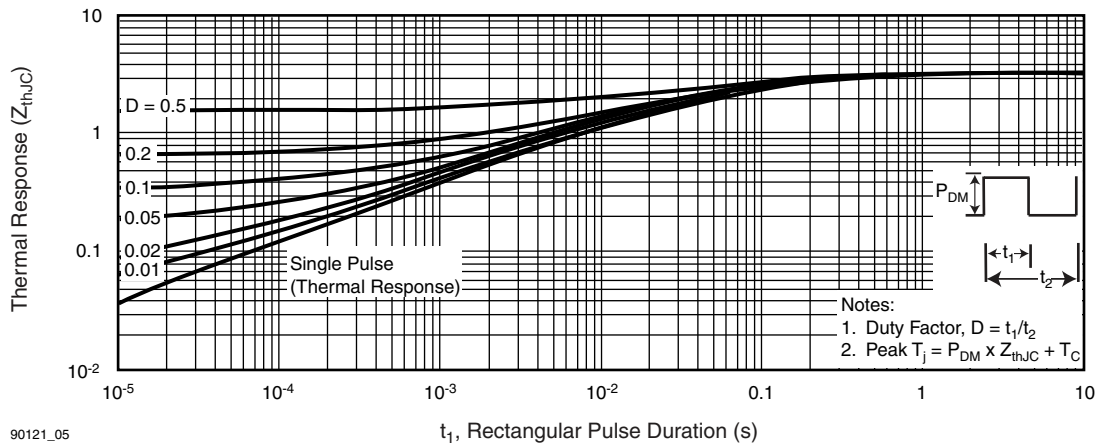

Fig. 13b - Unclamped Inductive Load Test Waveforms



90121_05

Fig. 14 - Maximum Effective Transient Thermal Impedance, Junction-to-Case vs. Pulse Duration

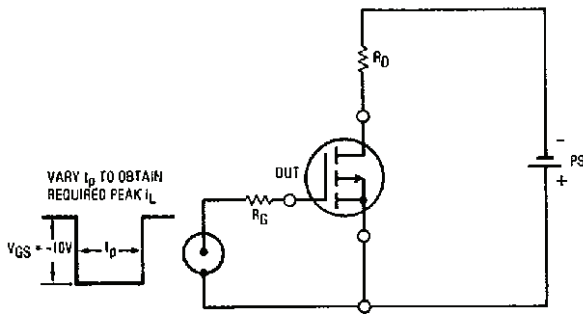

Fig. 15 - Switching Time Test Circuit

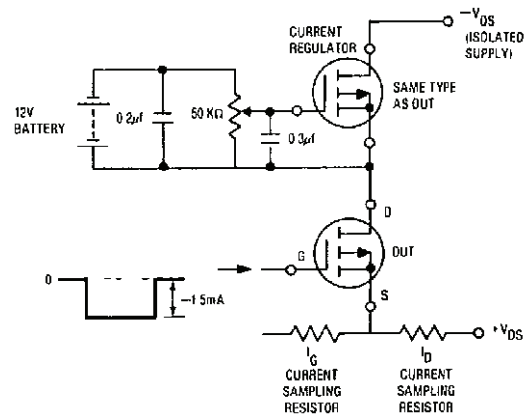

Fig. 16 - Gate Charge Test Circuit

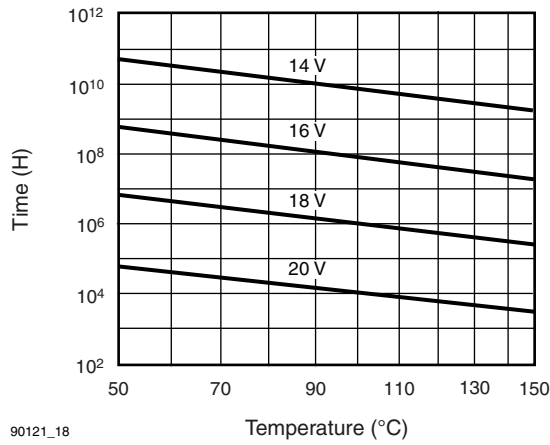

Fig. 17 - Typical Time to Accumulated 1 % Gate Failure

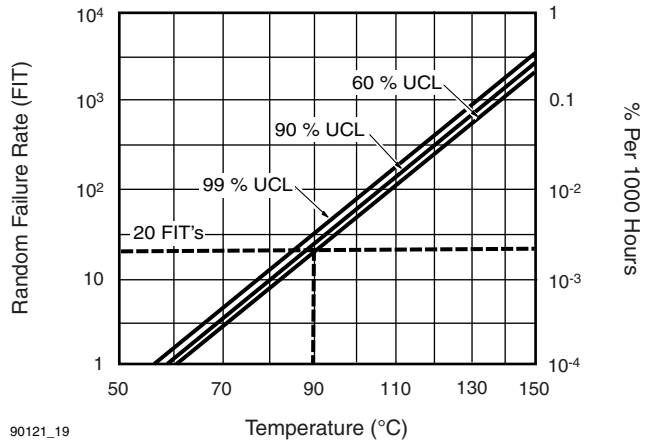

Fig. 18 - Typical High Temperature Reverse Bias (HTRB) Failure Rate

Vishay Siliconix maintains worldwide manufacturing capability. Products may be manufactured at one of several qualified locations. Reliability data for Silicon Technology and Package Reliability represent a composite of all qualified locations. For related documents such as package/tape drawings, part marking, and reliability data, see www.vishay.com/ppg?90121.



Disclaimer

ALL PRODUCT, PRODUCT SPECIFICATIONS AND DATA ARE SUBJECT TO CHANGE WITHOUT NOTICE TO IMPROVE RELIABILITY, FUNCTION OR DESIGN OR OTHERWISE.

Vishay Intertechnology, Inc., its affiliates, agents, and employees, and all persons acting on its or their behalf (collectively, "Vishay"), disclaim any and all liability for any errors, inaccuracies or incompleteness contained in any datasheet or in any other disclosure relating to any product.

Vishay makes no warranty, representation or guarantee regarding the suitability of the products for any particular purpose or the continuing production of any product. To the maximum extent permitted by applicable law, Vishay disclaims (i) any and all liability arising out of the application or use of any product, (ii) any and all liability, including without limitation special, consequential or incidental damages, and (iii) any and all implied warranties, including warranties of fitness for particular purpose, non-infringement and merchantability.

Statements regarding the suitability of products for certain types of applications are based on Vishay's knowledge of typical requirements that are often placed on Vishay products in generic applications. Such statements are not binding statements about the suitability of products for a particular application. It is the customer's responsibility to validate that a particular product with the properties described in the product specification is suitable for use in a particular application. Parameters provided in datasheets and / or specifications may vary in different applications and performance may vary over time. All operating parameters, including typical parameters, must be validated for each customer application by the customer's technical experts. Product specifications do not expand or otherwise modify Vishay's terms and conditions of purchase, including but not limited to the warranty expressed therein.

Except as expressly indicated in writing, Vishay products are not designed for use in medical, life-saving, or life-sustaining applications or for any other application in which the failure of the Vishay product could result in personal injury or death. Customers using or selling Vishay products not expressly indicated for use in such applications do so at their own risk. Please contact authorized Vishay personnel to obtain written terms and conditions regarding products designed for such applications.

No license, express or implied, by estoppel or otherwise, to any intellectual property rights is granted by this document or by any conduct of Vishay. Product names and markings noted herein may be trademarks of their respective owners.

Mouser Electronics

Authorized Distributor

Click to View Pricing, Inventory, Delivery & Lifecycle Information:

[Vishay:](#)

[IRF9Z20PBF](#) [IRF9Z20](#)