

TCK206G, TCK207G, TCK208G

0.75 V, 2A Load Switch IC with Reverse Current Blocking in Ultra Small Package

The TCK206G, TCK207G and TCK208G are 0.75 V ultra low voltage load switch ICs for a power management with slew rate control driver and reverse current blocking(SW OFF state) function.

Switch ON resistance is only 18.4 mΩ (typ.) at 0.75 V, -1.5 A condition and output current is available up to 2.0 A (DC). TCK207G and TCK208G feature output auto-discharge function.

These devices are available in 0.5 mm pitch ultra small package WCSP4C (0.9 mm x 0.9 mm, t: 0.5 mm) .Thus this devices is ideal for portable applications that require high-density board assembly such as cellular phone.

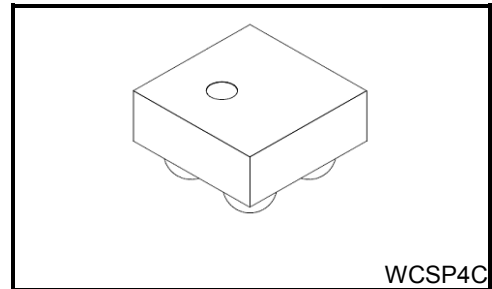

Weight : 0.9 mg (typ.)

Feature

- Low input voltage operation: $V_{IN} = 0.75$ to 3.6 V
- High output current: $I_{OUT} (DC) = 2.0$ A
- Low ON resistance :
 - $R_{ON} = 18.1$ mΩ (typ.) at $V_{IN} = 3.3$ V, -1.5 A
 - $R_{ON} = 18.2$ mΩ (typ.) at $V_{IN} = 1.2$ V, -1.5 A
 - $R_{ON} = 18.4$ mΩ (typ.) at $V_{IN} = 0.75$ V, -1.5 A
- Built in Slew rate control driver
- Built in Reverse current blocking(SW OFF state)
- Built in Auto-discharge (TCK207G and TCK208G)
- Active High and Pull down connection between CONTROL and GND (TCK206G and TCK207G)
- Active Low (TCK208G)
- Ultra small package : WCSP4C (0.9 mm x 0.9 mm, t: 0.5 mm)

Pin Assignment(Top view)

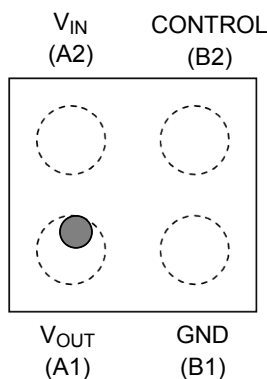

Top marking

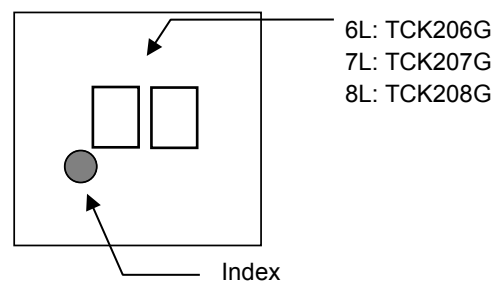

Start of commercial production
2014-06

Absolute Maximum Ratings (Ta = 25°C)

Characteristics	Symbol	Rating	Unit	
Input voltage	V_{IN}	-0.3 to 4.0	V	
Control voltage	V_{CT}	-0.3 to 4.0	V	
Output voltage	V_{OUT}	-0.3 to $V_{IN} + 0.3$	V	
Output current	I_{OUT}	DC	2.0	A
		Pulse	3.0 (Note 1)	A
Power dissipation	P_D	800 (Note 2)	mW	
Operating temperature range	T_{opr}	-40 to 85	°C	
Junction temperature	T_J	150	°C	
Storage temperature	T_{stg}	-55 to 150	°C	

Note : Using continuously under heavy loads (e.g. the application of high temperature/current/voltage and the significant change in temperature, etc.) may cause this product to decrease in the reliability significantly even if the operating conditions (i.e. operating temperature/current/voltage, etc.) are within the absolute maximum ratings. Please design the appropriate reliability upon reviewing the Toshiba Semiconductor Reliability Handbook (“Handling Precautions”/“Derating Concept and Methods”) and individual reliability data (i.e. reliability test report and estimated failure rate, etc.).

Note1: 100 μ s pulse, 2% duty cycle

Note2: Rating at mounting on a board

(Glass epoxy(FR4) board dimension : 40mm x 40mm, both sides of board

Metal pattern ratio : a surface approximately 50%, the reverse side approximately 50%

Through hole hole : diameter 0.5mm x 28)

Block Diagram

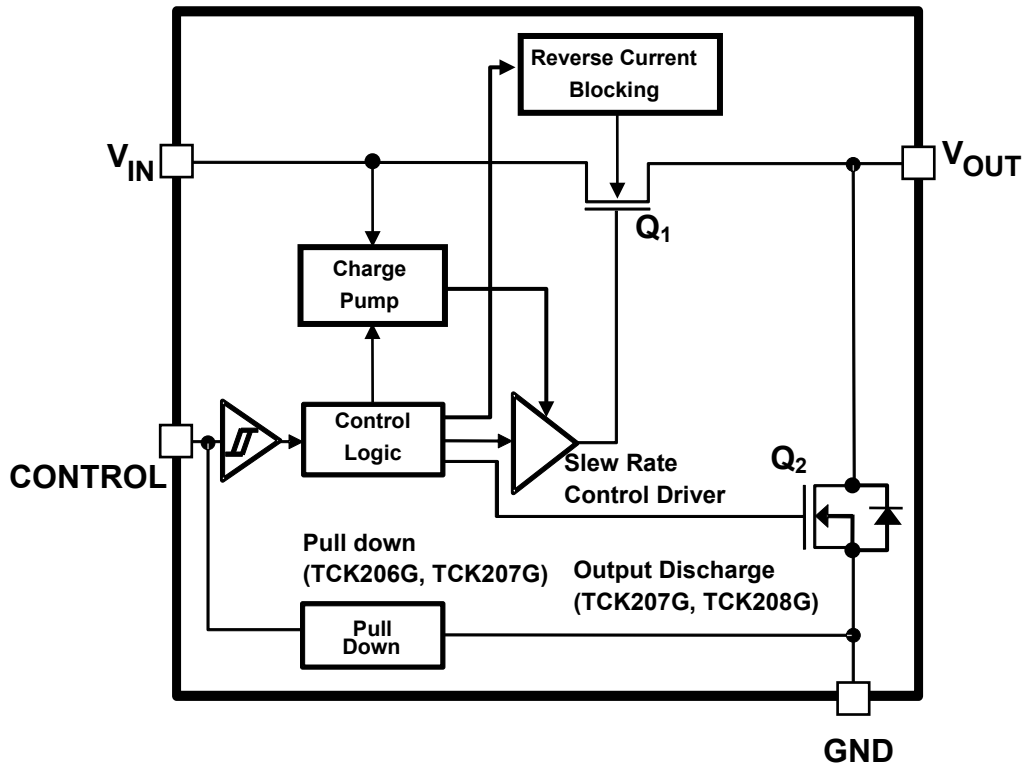

Function Table

Part number	Function		
	Reverse current blocking	Output auto-discharge	Control pin connection
TCK206G	Built in	N/A	Pull down (Active High)
TCK207G	Built in	Built in	Pull down (Active High)
TCK208G	Built in	Built in	OPEN (Active Low)

Operation Logic Table

$0.75\text{ V} \leq V_{IN} \leq 3.6\text{ V}$ ($T_a = -40$ to 85°C)

		TCK206G	TCK207G	TCK208G
Control voltage "High"	Output Q ₁	ON	ON	OFF
	Discharge Q ₂	—	OFF	ON
	Reverse current block	Disable	Disable	Active
Control voltage "Low"	Output Q ₁	OFF	OFF	ON
	Discharge Q ₂	—	ON	OFF
	Reverse current block	Active	Active	Disable
Control voltage "OPEN"	Output Q ₁	OFF	OFF	—
	Discharge Q ₂	—	ON	—
	Reverse current block	Active	Active	—

Electrical Characteristics

DC Characteristics (Ta = -40 to 85°C)

Characteristics	Symbol	Test Condition	Ta = 25°C			Ta = -40 to 85°C		Unit	
			Min	Typ.	Max	Min	Max		
Input voltage	V _{IN}	—	0.75	—	3.6	0.75	3.6	V	
CONTROL High-level input voltage	V _{IH}	—	0.9 V ≤ V _{IN}	0.9	—	—	0.9	—	V
			V _{IN} < 0.9V	V _{IN}	—	—	V _{IN}	—	V
CONTROL Low-level input voltage	V _{IL}	—	0.9 V ≤ V _{IN}	—	—	0.4	—	0.4	V
			V _{IN} < 0.9V	—	—	0.3	—	0.3	V
Quiescent current (ON state)	I _Q	V _{IN} = V _{CT} = 3.6 V, I _{OUT} = 0 mA	TCK206G TCK207G	—	22	—	—	35	μA
		V _{IN} = 3.6 V, V _{CT} = 0 V, I _{OUT} = 0 mA	TCK208G						
Standby current (SW OFF state)	I _{Q(OFF)}	V _{IN} = 3.6 V, V _{CT} = 0 V, V _{OUT} = OPEN (Note 3)	TCK206G TCK207G	—	0.7	—	—	5	μA
		V _{IN} = V _{CT} = 3.6 V, V _{OUT} = OPEN (Note 3)	TCK208G						
Reverse blocking current	I _{RB}	V _{OUT} = 3.6 V, V _{IN} = 0 V, V _{CT} = 0 V		—	0.1	—	—	10	μA
On resistance	R _{ON}	V _{IN} = 3.3 V, I _{OUT} = -1.5 A		—	18.1	—	—	28	mΩ
		V _{IN} = 1.8 V, I _{OUT} = -1.5 A		—	18.1	—	—	—	
		V _{IN} = 1.2 V, I _{OUT} = -1.5 A		—	18.2	—	—	—	
		V _{IN} = 1.0 V, I _{OUT} = -1.5 A		—	18.2	—	—	—	
		V _{IN} = 0.75 V, I _{OUT} = -1.5 A		—	18.4	—	—	28	
Discharge on resistance	R _{SD}	— (TCK207G and TCK208G)		—	380	—	—	Ω	

Note 3 : Except SW OFF state switch current (I_{SD(OFF)} : V_{IN} = 5.5 V, V_{CT} = 0 V, V_{OUT} = GND).

AC Characteristics (Ta = 25°C)

V_{IN} = 0.75 V

Characteristics	Symbol	Test Condition(Figure 1)	Min	Typ.	Max	Unit	
V _{OUT} rise time	t _r	R _L =500Ω , C _L =0.1μF	—	180	—	μs	
V _{OUT} fall time	t _f	R _L =500Ω , C _L =0.1μF	TCK207G TCK208G	—	50	—	μs
			TCK206G	—	80	—	
Turn on delay	t _{ON}	R _L =500Ω , C _L =0.1μF	—	75	—	μs	
Turn off delay	t _{OFF}	R _L =500Ω , C _L =0.1μF	TCK206G TCK207G	—	8	—	μs
			TCK208G	—	14	—	

V_{IN} = 1.2 V

Characteristics	Symbol	Test Condition(Figure 1)	Min	Typ.	Max	Unit	
V _{OUT} rise time	t _r	R _L =500Ω , C _L =0.1μF	—	240	—	μs	
V _{OUT} fall time	t _f	R _L =500Ω , C _L =0.1μF	TCK207G TCK208G	—	50	—	μs
			TCK206G	—	90	—	
Turn on delay	t _{ON}	R _L =500Ω , C _L =0.1μF	—	65	—	μs	
Turn off delay	t _{OFF}	R _L =500Ω , C _L =0.1μF	TCK206G TCK207G	—	8	—	μs
			TCK208G	—	13	—	

AC Waveform

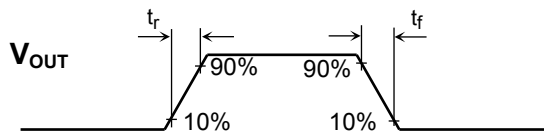

TCK206G, TCK207G

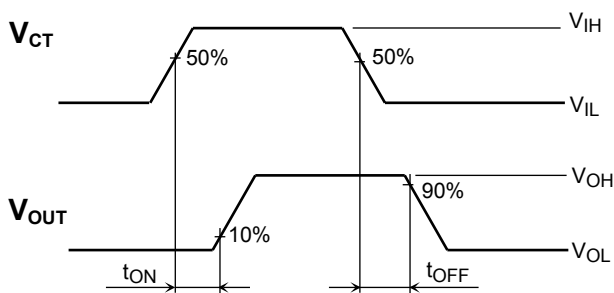

TCK208G

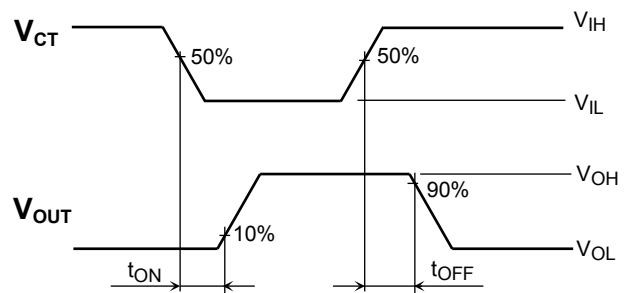
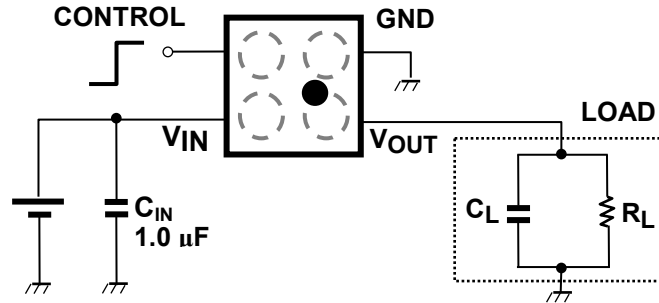

Figure 1 t_r, t_f, t_{ON}, t_{OFF} Waveforms

Application Note

1. Application circuit example (top view)

The figure below shows the recommended configuration for TCK206G, TCK207G and TCK208G.



1) Input capacitor

An input capacitor (C_{IN}) is necessary for the stable operation of TCK206G, TCK207G and TCK208G. And it is effective to reduce voltage drop due to sharp changes in output current and also for improved stability of the power supply. When used, place C_{IN} more than $1.0 \mu\text{F}$ as close to V_{IN} pin to improve stability of the power supply.

2) Output capacitor

An output capacitor (C_{OUT}) is not necessary for the guaranteed operation of TCK206G, TCK207G and TCK208G. However, there is a possibility of overshoot or undershoot caused by output load transient response, board layout and parasitic components of load switch IC. In this case, an output capacitor with C_{OUT} more than $0.1 \mu\text{F}$ is recommended.

3) Control pin

A control pins for TCK206G and TCK207G are both Active High and TCK208G is Active Low. These controls both the pass-through n-ch MOSFET and the discharge n-ch MOSFET (except TCK206G), operated by the control voltage and Schmitt trigger. When the control voltage level is High (Low; TCK208G), Output n-ch MOSFET is ON state and discharge n-ch MOSFET is SW OFF state. When control voltage level is Low (High; TCK208G), and the state of the MOSFETs is reversed. Also, pull down resistance equivalent to a few $\text{M}\Omega$ is connected between CONTROL and GND, thus the load switch IC is in SW OFF state even when CONTROL pin is OPEN(except TCK208G). In addition, CONTROL pin has a tolerant function such that it can be used even if the control voltage is higher than the input voltage.

2. Reverse current blocking

Reverse current blocking(SW OFF state) function is designed in these products. This function is active at output n-ch MOSEFT turned off.

However these does not assure for the suppression of uprising device operation. In use of these products, please read through and understand dissipation idea for absolute maximum ratings from the above mention or our 'Semiconductor Reliability Handbook'. Then use these products under absolute maximum ratings in any condition. Furthermore, Toshiba recommend inserting failsafe system into the design.

3. Power Dissipation

Board-mounted power dissipation ratings for TCK206G, TCK207G and TCK208G are available in the Absolute Maximum Ratings table

Power dissipation is measured on the board condition shown below.

[The Board Condition]

Board material: Glass epoxy (FR4)

Board dimension: 40mm x 40mm (both sides of board), t=1.8mm

Metal pattern ratio: a surface approximately 50%, the reverse side approximately 50%

Through hole: diameter 0.5mm x 28

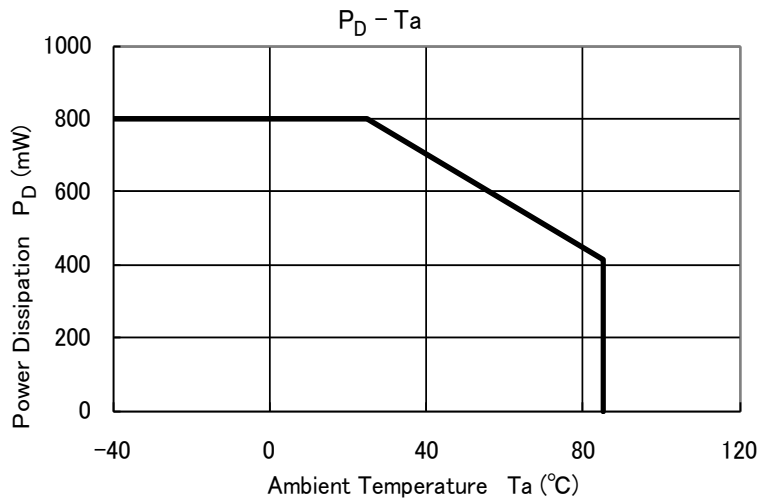

Please allow sufficient margin when designing a board pattern to fit the expected power dissipation. Also take into consideration the ambient temperature, input voltage, output current etc. and applying the appropriate derating for allowable power dissipation during operation.

Representative Typical Characteristics

1) ON resistance

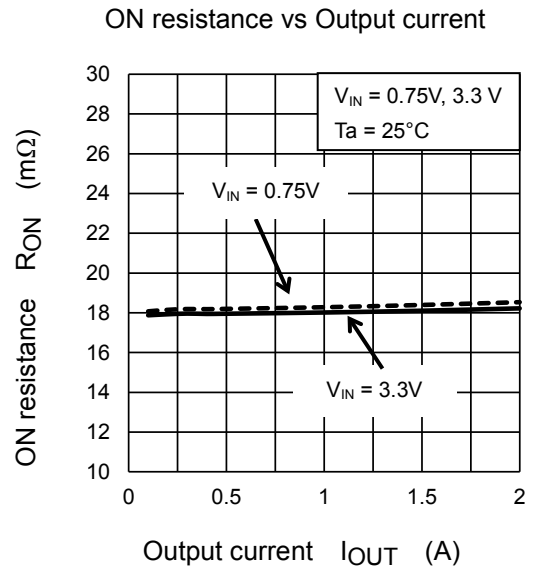
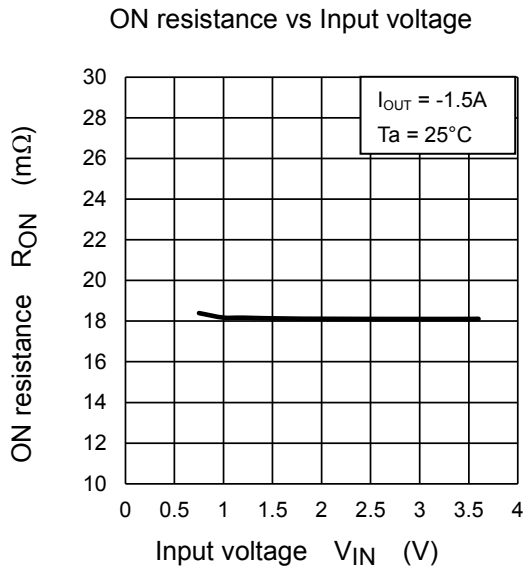

2) Quiescent current

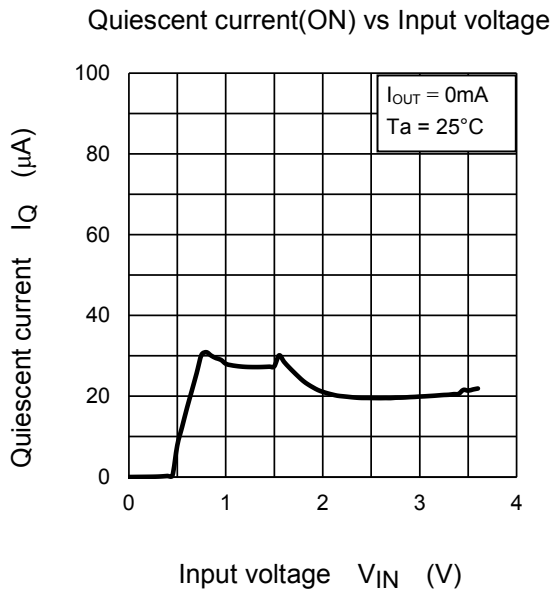

Package dimension

Unit: mm

WCSP4C

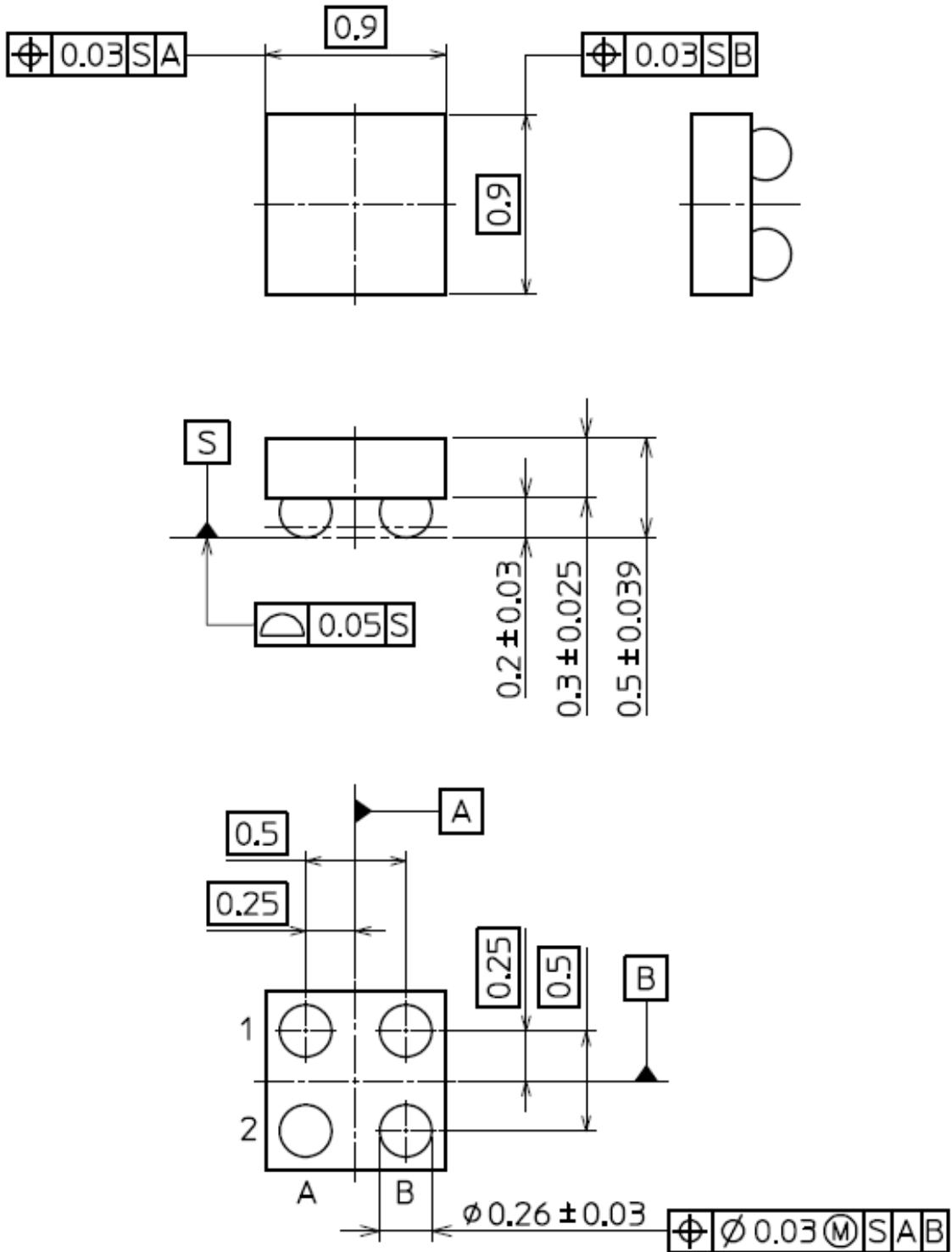

Weight : 0.9 mg (typ.)

Land pattern dimensions (for reference only)

Unit:mm

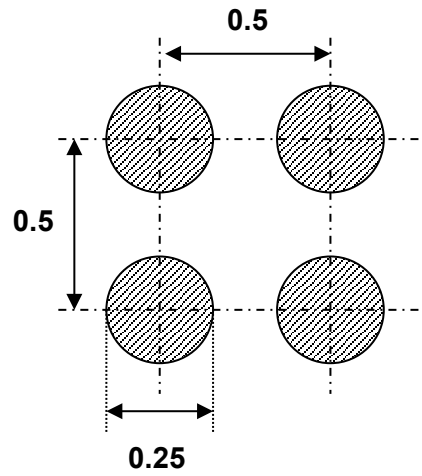

RESTRICTIONS ON PRODUCT USE

- Toshiba Corporation, and its subsidiaries and affiliates (collectively "TOSHIBA"), reserve the right to make changes to the information in this document, and related hardware, software and systems (collectively "Product") without notice.
- This document and any information herein may not be reproduced without prior written permission from TOSHIBA. Even with TOSHIBA's written permission, reproduction is permissible only if reproduction is without alteration/omission.
- Though TOSHIBA works continually to improve Product's quality and reliability, Product can malfunction or fail. Customers are responsible for complying with safety standards and for providing adequate designs and safeguards for their hardware, software and systems which minimize risk and avoid situations in which a malfunction or failure of Product could cause loss of human life, bodily injury or damage to property, including data loss or corruption. Before customers use the Product, create designs including the Product, or incorporate the Product into their own applications, customers must also refer to and comply with (a) the latest versions of all relevant TOSHIBA information, including without limitation, this document, the specifications, the data sheets and application notes for Product and the precautions and conditions set forth in the "TOSHIBA Semiconductor Reliability Handbook" and (b) the instructions for the application with which the Product will be used with or for. Customers are solely responsible for all aspects of their own product design or applications, including but not limited to (a) determining the appropriateness of the use of this Product in such design or applications; (b) evaluating and determining the applicability of any information contained in this document, or in charts, diagrams, programs, algorithms, sample application circuits, or any other referenced documents; and (c) validating all operating parameters for such designs and applications. **TOSHIBA ASSUMES NO LIABILITY FOR CUSTOMERS' PRODUCT DESIGN OR APPLICATIONS.**
- **PRODUCT IS NEITHER INTENDED NOR WARRANTED FOR USE IN EQUIPMENTS OR SYSTEMS THAT REQUIRE EXTRAORDINARILY HIGH LEVELS OF QUALITY AND/OR RELIABILITY, AND/OR A MALFUNCTION OR FAILURE OF WHICH MAY CAUSE LOSS OF HUMAN LIFE, BODILY INJURY, SERIOUS PROPERTY DAMAGE AND/OR SERIOUS PUBLIC IMPACT ("UNINTENDED USE").** Except for specific applications as expressly stated in this document, Unintended Use includes, without limitation, equipment used in nuclear facilities, equipment used in the aerospace industry, medical equipment, equipment used for automobiles, trains, ships and other transportation, traffic signaling equipment, equipment used to control combustions or explosions, safety devices, elevators and escalators, devices related to electric power, and equipment used in finance-related fields. **IF YOU USE PRODUCT FOR UNINTENDED USE, TOSHIBA ASSUMES NO LIABILITY FOR PRODUCT.** For details, please contact your TOSHIBA sales representative.
- Do not disassemble, analyze, reverse-engineer, alter, modify, translate or copy Product, whether in whole or in part.
- Product shall not be used for or incorporated into any products or systems whose manufacture, use, or sale is prohibited under any applicable laws or regulations.
- The information contained herein is presented only as guidance for Product use. No responsibility is assumed by TOSHIBA for any infringement of patents or any other intellectual property rights of third parties that may result from the use of Product. No license to any intellectual property right is granted by this document, whether express or implied, by estoppel or otherwise.
- **ABSENT A WRITTEN SIGNED AGREEMENT, EXCEPT AS PROVIDED IN THE RELEVANT TERMS AND CONDITIONS OF SALE FOR PRODUCT, AND TO THE MAXIMUM EXTENT ALLOWABLE BY LAW, TOSHIBA (1) ASSUMES NO LIABILITY WHATSOEVER, INCLUDING WITHOUT LIMITATION, INDIRECT, CONSEQUENTIAL, SPECIAL, OR INCIDENTAL DAMAGES OR LOSS, INCLUDING WITHOUT LIMITATION, LOSS OF PROFITS, LOSS OF OPPORTUNITIES, BUSINESS INTERRUPTION AND LOSS OF DATA, AND (2) DISCLAIMS ANY AND ALL EXPRESS OR IMPLIED WARRANTIES AND CONDITIONS RELATED TO SALE, USE OF PRODUCT, OR INFORMATION, INCLUDING WARRANTIES OR CONDITIONS OF MERCHANTABILITY, FITNESS FOR A PARTICULAR PURPOSE, ACCURACY OF INFORMATION, OR NONINFRINGEMENT.**
- Do not use or otherwise make available Product or related software or technology for any military purposes, including without limitation, for the design, development, use, stockpiling or manufacturing of nuclear, chemical, or biological weapons or missile technology products (mass destruction weapons). Product and related software and technology may be controlled under the applicable export laws and regulations including, without limitation, the Japanese Foreign Exchange and Foreign Trade Law and the U.S. Export Administration Regulations. Export and re-export of Product or related software or technology are strictly prohibited except in compliance with all applicable export laws and regulations.
- Please contact your TOSHIBA sales representative for details as to environmental matters such as the RoHS compatibility of Product. Please use Product in compliance with all applicable laws and regulations that regulate the inclusion or use of controlled substances, including without limitation, the EU RoHS Directive. **TOSHIBA ASSUMES NO LIABILITY FOR DAMAGES OR LOSSES OCCURRING AS A RESULT OF NONCOMPLIANCE WITH APPLICABLE LAWS AND REGULATIONS.**

Mouser Electronics

Authorized Distributor

Click to View Pricing, Inventory, Delivery & Lifecycle Information:

[Toshiba:](#)

[TCK206G,LF](#) [TCK208G,LF](#) [TCK207G,LF](#)