

# NCS333, NCV333, NCS2333, NCV2333, NCS4333, NCV4333

## 10 $\mu\text{V}$ Offset, 0.07 $\mu\text{V}/^\circ\text{C}$ , Low Power, Zero-Drift Operational Amplifier

The NCS333 family of high precision op amps feature very low input offset voltage and near-zero drift over time and temperature. These low quiescent current amplifiers have high impedance inputs with a common-mode range 100 mV beyond the rails as well as rail-to-rail output swing within 50 mV of the rails. These op amps operate over a wide supply range from 1.8 V to 5.5 V. The NCS333 family exhibits outstanding CMRR without the crossover associated with traditional complementary input stages. The NCS333, as well as the dual version, NCS2333, and the quad version, NCS4333, come in a variety of packages and pinouts. Automotive qualified options are available under NCV prefix.

### Features

- Low Offset Voltage: 10  $\mu\text{V}$  max for NCS333, 30  $\mu\text{V}$  max for NCS2333 and NCS4333
- Zero Drift: 0.07  $\mu\text{V}/^\circ\text{C}$  max
- Low Noise: 1.1  $\mu\text{Vpp}$ , 0.1 Hz to 10 Hz
- Quiescent Current per Channel: 17  $\mu\text{A}$  Typical at 3.3 V Supply
- Supply Voltage: 1.8 V to 5.5 V
- Rail-to-Rail Input and Output
- NCV Prefix for Automotive and Other Applications Requiring Unique Site and Control Change Requirements; AEC-Q100 Qualified and PPAP Capable
- These Devices are Pb-Free, Halogen Free/BFR Free and are RoHS Compliant

### Typical Applications

- Temperature Measurements
- Transducer Applications
- Current Sensing

### End Products

- Battery Powered Instruments
- Electronic Scales
- Medical Instrumentation

This document contains information on some products that are still under development. ON Semiconductor reserves the right to change or discontinue these products without notice.



ON Semiconductor®

[www.onsemi.com](http://www.onsemi.com)



SOT23-5  
SN SUFFIX  
CASE 483



SC70-5  
SQ SUFFIX  
CASE 419A



DFN-8  
MN SUFFIX  
CASE 506BW

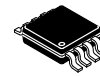

MSOP-8  
DM SUFFIX  
CASE 846A-02



SOIC-8  
D SUFFIX  
CASE 751



SOIC-14  
D SUFFIX  
CASE 751A

### DEVICE MARKING INFORMATION

See general marking information in the device marking section on page 2 of this data sheet.

### ORDERING INFORMATION

See detailed ordering and shipping information on page 3 of this data sheet.

# NCS333, NCV333, NCS2333, NCV2333, NCS4333, NCV4333

## DEVICE MARKING INFORMATION

### Single Channel Configuration NCS333, NCV333

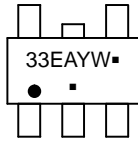

TSOP-5/SOT23-5  
CASE 483

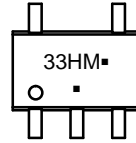

SC70-5  
CASE 419A

### Dual Channel Configuration NCS2333, NCV2333

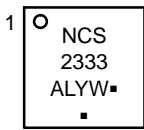

DFN8, 3x3, 0.65P  
CASE 506BW

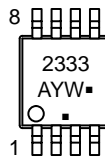

Micro8/MSOP8  
CASE 846A-02

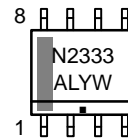

SOIC-8  
CASE 751

### Quad Channel Configuration NCS4333, NCV4333

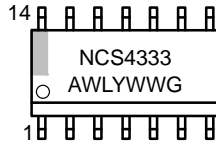

SOIC-14  
CASE 751A

- 33E = Specific Device Code (SOT23-5)
- 33H = Specific Device Code (SC70-5)
- A = Assembly Location
- Y = Year
- W = Work Week
- M = Date Code
- G or ■ = Pb-Free Package

(Note: Microdot may be in either location)

# NCS333, NCV333, NCS2333, NCV2333, NCS4333, NCV4333

## PIN CONNECTIONS

### Single Channel Configuration NCS333, NCV333

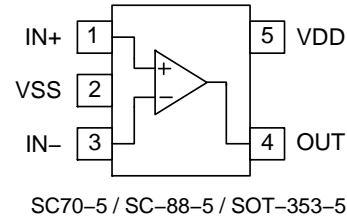
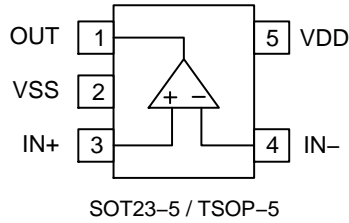

### Dual Channel Configuration NCS2333, NCV2333

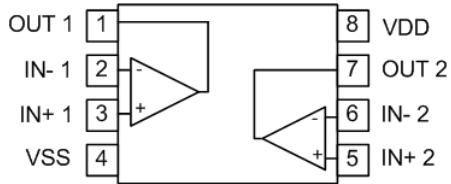

### Quad Channel Configuration NCS4333, NCV4333

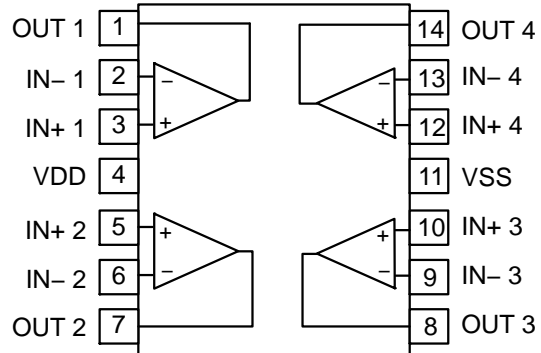

## ORDERING INFORMATION

Configuration	Automotive	Device	Package	Shipping †
Single	No	NCS333SN2T1G	SOT23-5 / TSOP-5	3000 / Tape & Reel
		NCS333ASN2T1G* (In Development)		3000 / Tape & Reel
	Yes	NCS333SQ3T2G	SC70-5 / SC-88-5 / SOT-353-5	3000 / Tape & Reel
		NCS333ASQ3T2G* (In Development)		3000 / Tape & Reel
Dual	No	NCS2333MNTXG* (In Development)	DFN8	3000 / Tape & Reel
		NCS2333DR2G	SOIC-8	2500 / Tape & Reel
		NCS2333DMR2G	MICRO-8	4000 / Tape & Reel
	Yes	NCV2333DR2G	SOIC-8	2500 / Tape & Reel
		NCV2333DMR2G* (In Development)	MICRO-8	4000 / Tape & Reel
Quad	No	NCS4333DR2G* (In Development)	SOIC-14	2500 / Tape & Reel
	Yes	NCV4333DR2G* (In Development)	SOIC-14	2500 / Tape & Reel

†For information on tape and reel specifications, including part orientation and tape sizes, please refer to our Tape and Reel Packaging Specifications Brochure, BRD8011/D.

\*Contact local sales office for more information

# NCS333, NCV333, NCS2333, NCV2333, NCS4333, NCV4333

## ABSOLUTE MAXIMUM RATINGS

Over operating free-air temperature, unless otherwise stated.

Parameter	Rating	Unit
Supply Voltage	7	V

## INPUT AND OUTPUT PINS

Input Voltage (Note 1)	(VSS) – 0.3 to (VDD) + 0.3	V
Input Current (Note 1)	±10	mA
Output Short Circuit Current (Note 2)	Continuous	

## TEMPERATURE

Operating Temperature	–40 to +125	°C
Storage Temperature	–65 to +150	°C
Junction Temperature	–65 to +150	°C

## ESD RATINGS (Note 3)

Human Body Model (HBM)	4000	V
Machine Model (MM)	200	V
Charged Device Model (CDM)	2000	V

## OTHER RATINGS

Latch-up Current (Note 4)	100	mA
MSL	Level 1	

Stresses exceeding those listed in the Maximum Ratings table may damage the device. If any of these limits are exceeded, device functionality should not be assumed, damage may occur and reliability may be affected.

- Input terminals are diode-clamped to the power-supply rails. Input signals that can swing more than 0.3 V beyond the supply rails should be current limited to 10 mA or less
- Short-circuit to ground.
- This device series incorporates ESD protection and is tested by the following methods:  
ESD Human Body Model tested per AEC-Q100-002 (JEDEC standard: JESD22-A114)  
ESD Machine Model tested per AEC-Q100-003 (JEDEC standard: JESD22-A115)
- Latch-up Current tested per JEDEC standard: JESD78.

## THERMAL INFORMATION (Note 5)

Parameter	Symbol	Package	Value	Unit
Thermal Resistance, Junction to Ambient	$\theta_{JA}$	SOT23-5/ TSOP5	290	°C/W
		SC70-5 / SC-88-5 / SOT-353-5	425	
		Micro8/MSOP8	298	
		SOIC-8	250	
		DFN-8	130	
		SOIC-14	216	

- As mounted on an 80x80x1.5 mm FR4 PCB with 650 mm<sup>2</sup> and 2 oz (0.034 mm) thick copper heat spreader. Following JEDEC JESD/EIA 51.1, 51.2, 51.3 test guidelines

## RECOMMENDED OPERATING CONDITIONS

Parameter	Symbol	Range	Unit	
Supply Voltage (V <sub>DD</sub> – V <sub>SS</sub> )	V <sub>S</sub>	1.8 to 5.5	V	
Specified Operating Range	NCS333 NCS333A, NCV333, NCx2333, NCx4333	T <sub>A</sub>	–40 to 105	°C
			–40 to 125	
Input Common Mode Voltage Range	V <sub>ICMR</sub>	V <sub>SS</sub> –0.1 to V <sub>DD</sub> +0.1	V	

Functional operation above the stresses listed in the Recommended Operating Ranges is not implied. Extended exposure to stresses beyond the Recommended Operating Ranges limits may affect device reliability.

# NCS333, NCV333, NCS2333, NCV2333, NCS4333, NCV4333

**ELECTRICAL CHARACTERISTICS:**  $V_S = 1.8\text{ V to }5.5\text{ V}$

At  $T_A = +25^\circ\text{C}$ ,  $R_L = 10\text{ k}\Omega$  connected to midsupply,  $V_{CM} = V_{OUT} = \text{midsupply}$ , unless otherwise noted.

**Boldface** limits apply over the specified temperature range, guaranteed by characterization and/or design.

Parameter	Symbol	Conditions	Min	Typ	Max	Unit	
<b>INPUT CHARACTERISTICS</b>							
Offset Voltage	$V_{OS}$	$V_S = +5\text{ V}$	NCS333		3.5	10	$\mu\text{V}$
			NCx2333, NCx4333		6.0	30	
Offset Voltage Drift vs Temp	$\Delta V_{OS}/\Delta T$	NCS333			<b>0.03</b>	<b>0.07</b>	$\mu\text{V}/^\circ\text{C}$
		NCx2333, NCx4333, $V_S = 5\text{ V}$			<b>0.04</b>	<b>0.07</b>	
Offset Voltage Drift vs Supply	$\Delta V_{OS}/\Delta V_S$	NCS333	Full temperature range		<b>0.32</b>	<b>5</b>	$\mu\text{V}/\text{V}$
		NCx2333, NCx4333	$T_A = +25^\circ\text{C}$		0.32	5	
			Full temperature range			<b>12.6</b>	
Input Bias Current	$I_{IB}$	$T_A = +25^\circ\text{C}$	NCS333		$\pm 60$	$\pm 200$	$\text{pA}$
			NCx2333, NCx4333		$\pm 60$	$\pm 400$	
			Full temperature range			<b><math>\pm 400</math></b>	
Input Offset Current	$I_{OS}$	$T_A = +25^\circ\text{C}$	NCS333		$\pm 50$	$\pm 400$	$\text{pA}$
			NCx2333, NCx4333		$\pm 50$	$\pm 800$	
Common Mode Rejection Ratio	CMRR	$V_{SS} - 0.1 < V_{CM} < V_{DD} + 0.1$	$V_S = 1.8\text{ V}$		111		dB
			$V_S = 3.3\text{ V}$		118		
			$V_S = 5.0\text{ V}$	106	123		
			$V_S = 5.5\text{ V}$		127		
Input Resistance	$R_{IN}$	Differential			180		$\text{G}\Omega$
		Common Mode			90		
Input Capacitance	$C_{IN}$	NCS333	Differential		2.3		$\text{pF}$
			Common Mode		4.6		
		NCx2333, NCx4333	Differential		4.1		
			Common Mode		7.9		
<b>OUTPUT CHARACTERISTICS</b>							
Open Loop Voltage Gain	$A_{VOL}$	$V_{SS} + 100\text{ mV} < V_O < V_{DD} - 100\text{ mV}$		<b>106</b>	145		dB
Open Loop Output Impedance	$Z_{out-OL}$	$f = \text{UGBW}$ , $I_O = 0\text{ mA}$			300		$\Omega$
Output Voltage High, Referenced to $V_{DD}$	$V_{OH}$	$T_A = +25^\circ\text{C}$			10	50	mV
		Full temperature range				<b>70</b>	
Output Voltage Low, Referenced to $V_{SS}$	$V_{OL}$	$T_A = +25^\circ\text{C}$			10	50	mV
		Full temperature range				<b>70</b>	
Output Current Capability	$I_O$	Sinking Current	NCS333		25		mA
			NCx2333, NCx4333		11		
		Sourcing Current				5.0	
Capacitive Load Drive	$C_L$			See Figure 13			

# NCS333, NCV333, NCS2333, NCV2333, NCS4333, NCV4333

## ELECTRICAL CHARACTERISTICS: $V_S = 1.8\text{ V to }5.5\text{ V}$

At  $T_A = +25^\circ\text{C}$ ,  $R_L = 10\text{ k}\Omega$  connected to midsupply,  $V_{CM} = V_{OUT} = \text{midsupply}$ , unless otherwise noted.

**Boldface** limits apply over the specified temperature range, guaranteed by characterization and/or design.

Parameter	Symbol	Conditions	Min	Typ	Max	Unit
-----------	--------	------------	-----	-----	-----	------

### NOISE PERFORMANCE

Voltage Noise Density	$e_N$	$f_{IN} = 1\text{ kHz}$		62		nV / $\sqrt{\text{Hz}}$
Voltage Noise	$e_{P-P}$	$f_{IN} = 0.1\text{ Hz to }10\text{ Hz}$		1.1		$\mu\text{V}_{PP}$
		$f_{IN} = 0.01\text{ Hz to }1\text{ Hz}$		0.5		
Current Noise Density	$i_N$	$f_{IN} = 10\text{ Hz}$		350		fA / $\sqrt{\text{Hz}}$
Channel Separation		NCx2333, NCx4333		135		dB

### DYNAMIC PERFORMANCE

Gain Bandwidth Product	GBWP	$C_L = 100\text{ pF}$	NCS333, NCx4333		350		kHz
			NCx2333		270		
Gain Margin	$A_M$	$C_L = 100\text{ pF}$		18		dB	
Phase Margin	$\phi_M$	$C_L = 100\text{ pF}$		55		$^\circ$	
Slew Rate	SR	$G = +1$		0.15		V/ $\mu\text{s}$	

### POWER SUPPLY

Power Supply Rejection Ratio	PSRR	NCS333	Full temperature range	<b>106</b>	130		dB
		NCx2333, NCx4333, NCV333	$T_A = +25^\circ\text{C}$	106	130		
			Full temperature range	<b>98</b>			
Turn-on Time	$t_{ON}$	$V_S = 5\text{ V}$			100		$\mu\text{s}$
Quiescent Current	$I_Q$	No load, per channel	$1.8\text{ V} \leq V_S \leq 3.3\text{ V}$		17	25	$\mu\text{A}$
						<b>27</b>	
			$3.3\text{ V} < V_S \leq 5.5\text{ V}$		21	33	

Product parametric performance is indicated in the Electrical Characteristics for the listed test conditions, unless otherwise noted. Product performance may not be indicated by the Electrical Characteristics if operated under different conditions.

TYPICAL CHARACTERISTICS

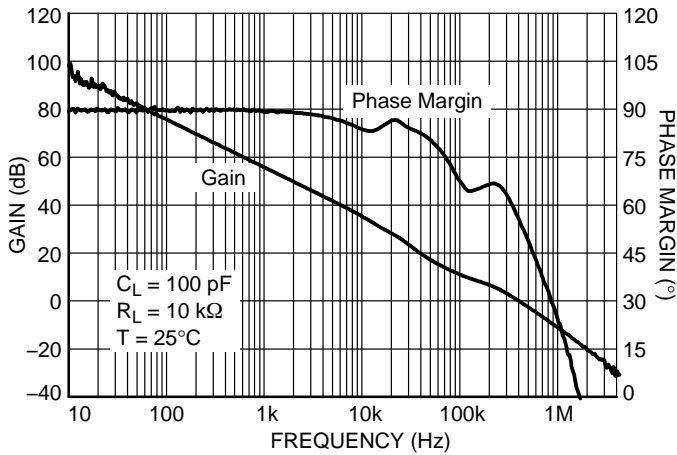

Figure 1. Open Loop Gain and Phase Margin vs. Frequency

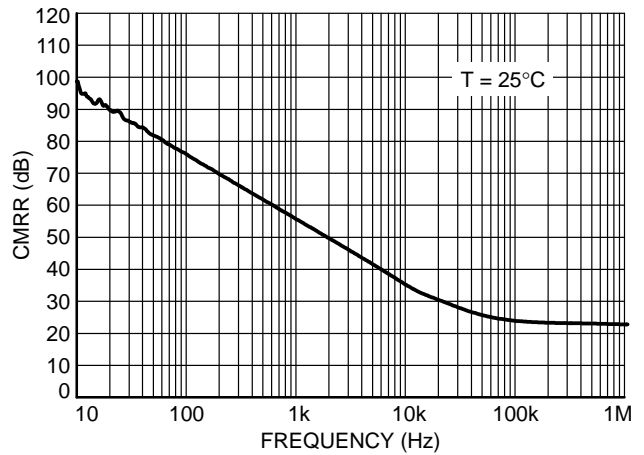

Figure 2. CMRR vs. Frequency

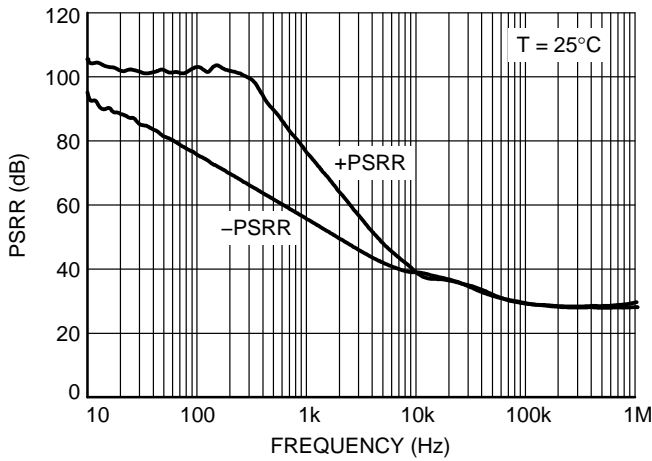

Figure 3. PSRR vs. Frequency

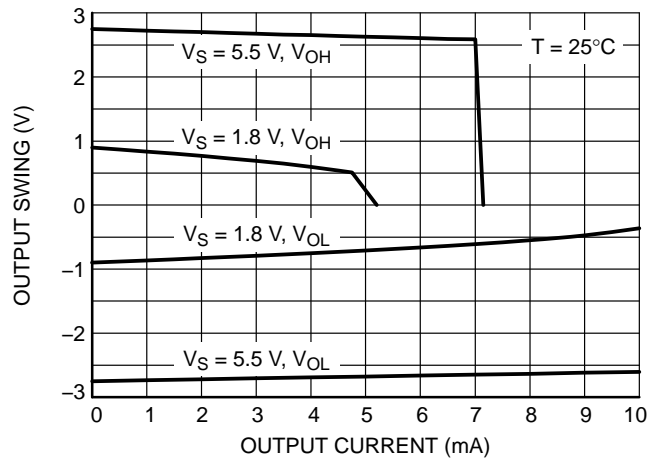

Figure 4. Output Voltage Swing vs. Output Current

TYPICAL CHARACTERISTICS

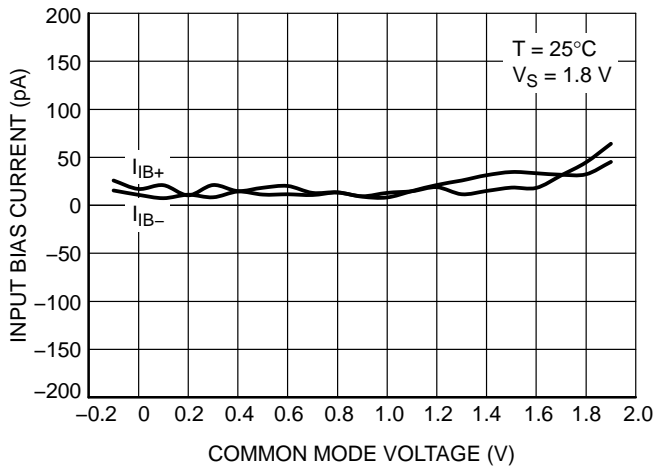

Figure 5. Input Bias Current vs. Common Mode Voltage

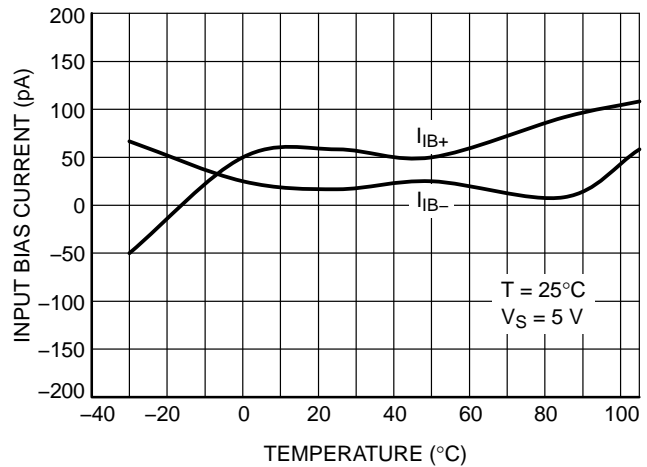

Figure 6. Input Bias Current vs. Temperature

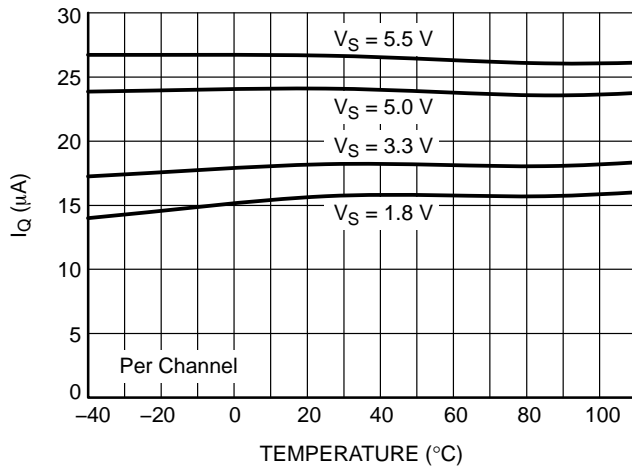

Figure 7. Quiescent Current vs. Temperature

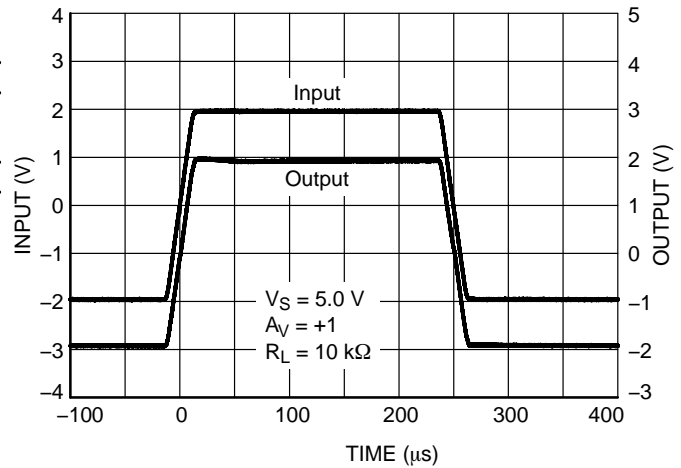

Figure 8. Large Signal Step Response

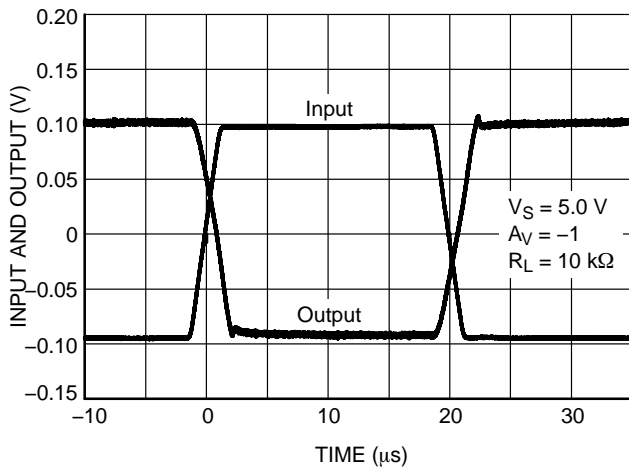

Figure 9. Small Signal Step Response

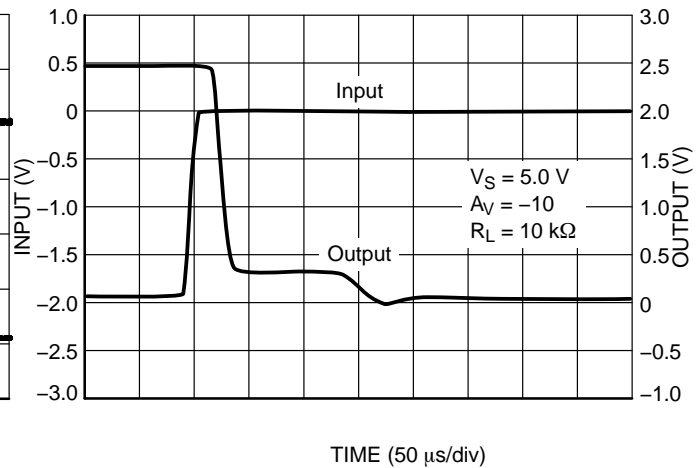

Figure 10. Positive Overtolerance Recovery



TYPICAL CHARACTERISTICS

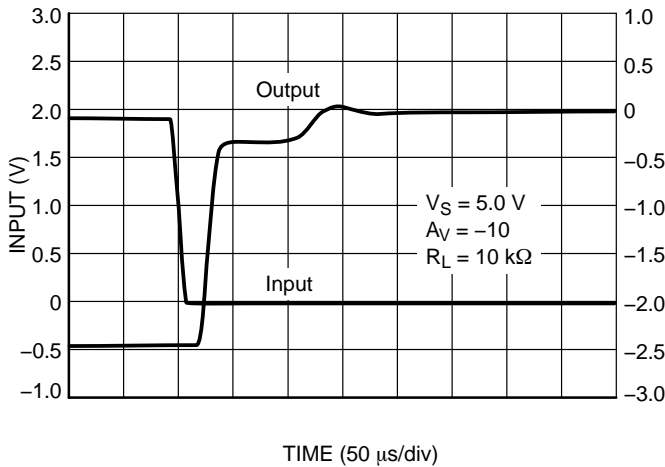

Figure 11. Negative Overtolerance Recovery

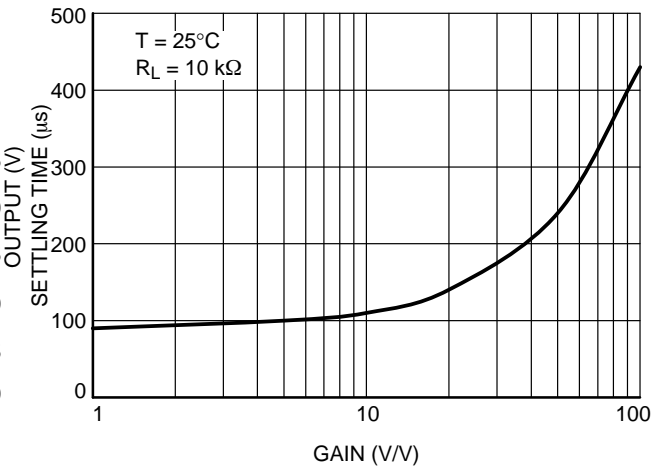

Figure 12. Settling Time to 0.1% vs. Closed-Loop Gain

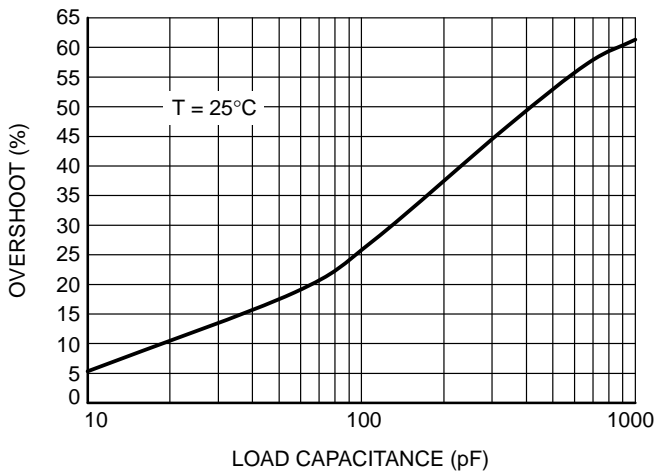

Figure 13. Small-Signal Overshoot vs. Load Capacitance

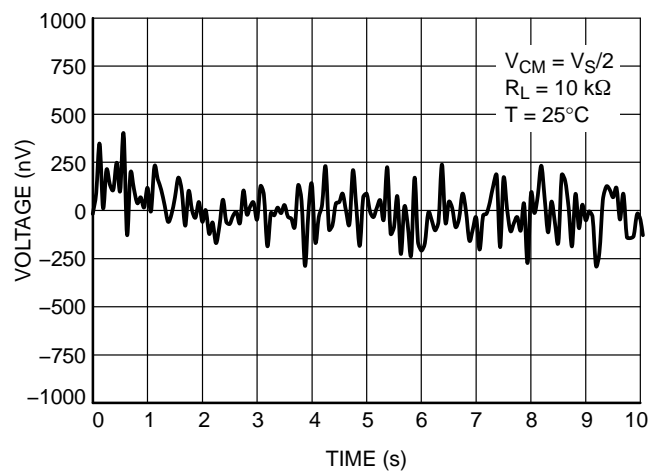

Figure 14. 0.1 Hz to 10 Hz Noise

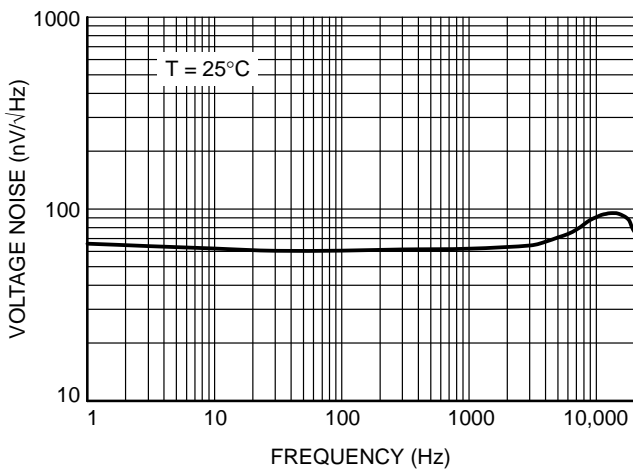

Figure 15. Voltage Noise Density vs. Frequency

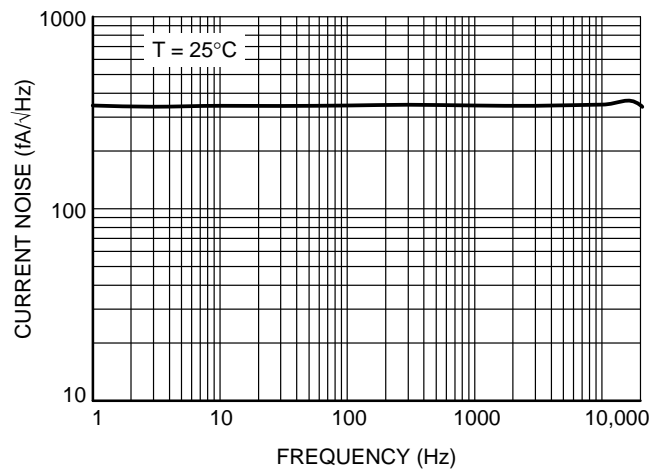

Figure 16. Current Noise Density vs. Frequency

APPLICATIONS INFORMATION

APPLICATION CIRCUITS

Low-Side Current Sensing

The goal of low-side current sensing is to detect over-current conditions or as a method of feedback control. A sense resistor is placed in series with the load to ground. Typically, the value of the sense resistor is less than 100 mΩ

to reduce power loss across the resistor. The op amp amplifies the voltage drop across the sense resistor with a gain set by external resistors R1, R2, R3, and R4 (where R1 = R2, R3 = R4). Precision resistors are required for high accuracy, and the gain is set to utilize the full scale of the ADC for the highest resolution.

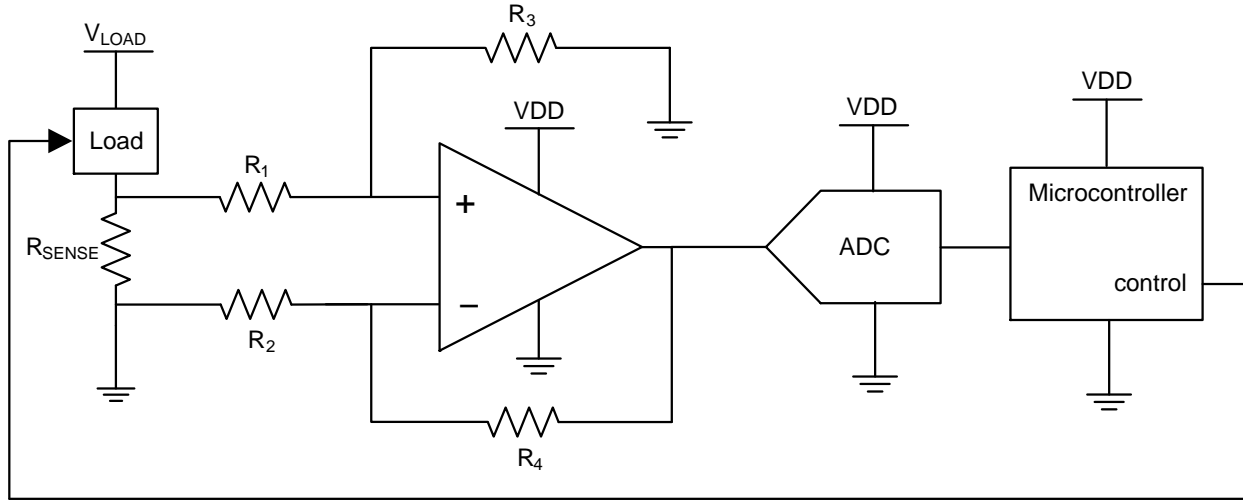

Figure 17. Low-Side Current Sensing

Differential Amplifier for Bridged Circuits

Sensors to measure strain, pressure, and temperature are often configured in a Wheatstone bridge circuit as shown in Figure 18. In the measurement, the voltage change that is

produced is relatively small and needs to be amplified before going into an ADC. Precision amplifiers are recommended in these types of applications due to their high gain, low noise, and low offset voltage.

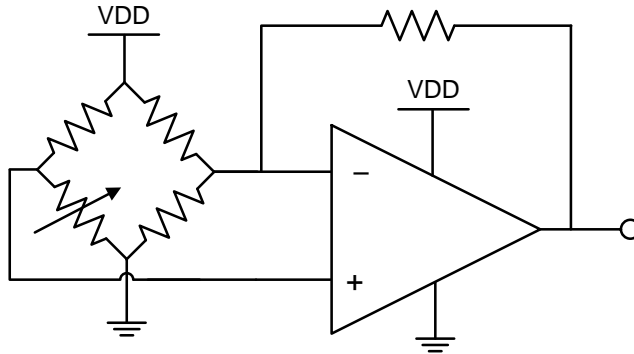

Figure 18. Bridge Circuit Amplification

EMI Susceptibility and Input Filtering

Op amps have varying amounts of EMI susceptibility. Semiconductor junctions can pick up and rectify EMI signals, creating an EMI-induced voltage offset at the output, adding another component to the total error. Input pins are the most sensitive to EMI. The NCS333 op amp family integrates low-pass filters to decrease sensitivity to EMI.

General Layout Guidelines

To ensure optimum device performance, it is important to follow good PCB design practices. Place 0.1 μF decoupling capacitors as close as possible to the supply pins. Keep traces short, utilize a ground plane, choose surface-mount components, and place components as close as possible to the device pins. These techniques will reduce susceptibility to electromagnetic interference (EMI). Thermoelectric effects can create an additional temperature dependent offset voltage at the input pins. To reduce these effects, use metals with low thermoelectric-coefficients and prevent temperature gradients from heat sources or cooling fans.

PACKAGE DIMENSIONS

SC-88A (SC-70-5/SOT-353)  
CASE 419A-02  
ISSUE L

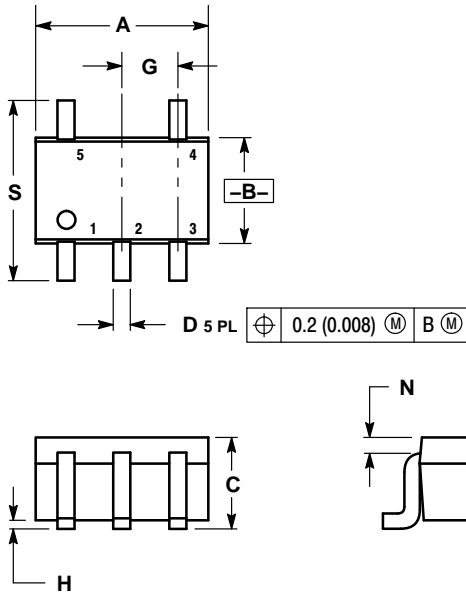

NOTES:

1. DIMENSIONING AND TOLERANCING PER ANSI Y14.5M, 1982.
2. CONTROLLING DIMENSION: INCH.
3. 419A-01 OBSOLETE. NEW STANDARD 419A-02.
4. DIMENSIONS A AND B DO NOT INCLUDE MOLD FLASH, PROTRUSIONS, OR GATE BURRS.

DIM	INCHES		MILLIMETERS	
	MIN	MAX	MIN	MAX
A	0.071	0.087	1.80	2.20
B	0.045	0.053	1.15	1.35
C	0.031	0.043	0.80	1.10
D	0.004	0.012	0.10	0.30
G	0.026 BSC		0.65 BSC	
H	---	0.004	---	0.10
J	0.004	0.010	0.10	0.25
K	0.004	0.012	0.10	0.30
N	0.008 REF		0.20 REF	
S	0.079	0.087	2.00	2.20

SOLDER FOOTPRINT

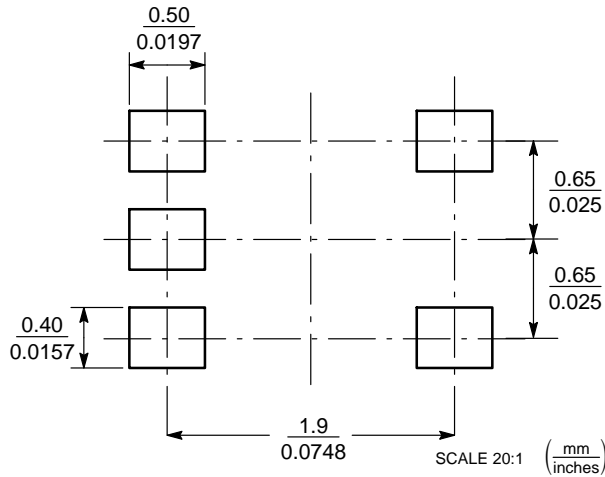

\*For additional information on our Pb-Free strategy and soldering details, please download the ON Semiconductor Soldering and Mounting Techniques Reference Manual, SOLDERRM/D.

PACKAGE DIMENSIONS

TSOP-5  
CASE 483-02  
ISSUE K

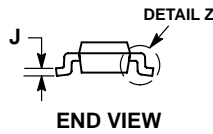
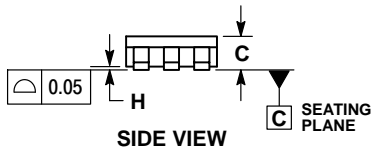
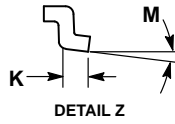
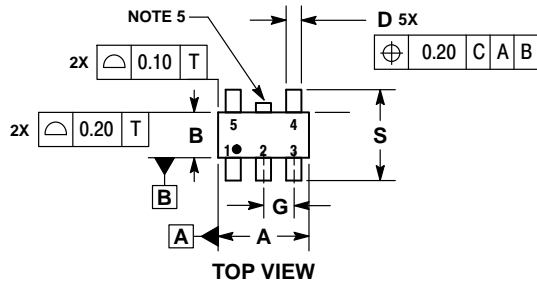

NOTES:

1. DIMENSIONING AND TOLERANCING PER ASME Y14.5M, 1994.
2. CONTROLLING DIMENSION: MILLIMETERS.
3. MAXIMUM LEAD THICKNESS INCLUDES LEAD FINISH THICKNESS. MINIMUM LEAD THICKNESS IS THE MINIMUM THICKNESS OF BASE MATERIAL.
4. DIMENSIONS A AND B DO NOT INCLUDE MOLD FLASH, PROTRUSIONS, OR GATE BURRS. MOLD FLASH, PROTRUSIONS, OR GATE BURRS SHALL NOT EXCEED 0.15 PER SIDE, DIMENSION A.
5. OPTIONAL CONSTRUCTION: AN ADDITIONAL TRIMMED LEAD IS ALLOWED IN THIS LOCATION. TRIMMED LEAD NOT TO EXTEND MORE THAN 0.2 FROM BODY.

DIM	MILLIMETERS	
	MIN	MAX
A	3.00 BSC	
B	1.50 BSC	
C	0.90	1.10
D	0.25	0.50
G	0.95 BSC	
H	0.01	0.10
J	0.10	0.26
K	0.20	0.60
M	0° 10°	
S	2.50	3.00

SOLDERING FOOTPRINT\*

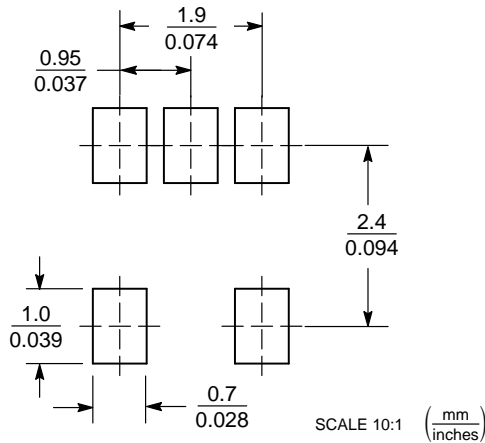

\*For additional information on our Pb-Free strategy and soldering details, please download the ON Semiconductor Soldering and Mounting Techniques Reference Manual, SOLDERRM/D.

PACKAGE DIMENSIONS

DFN8, 3x3, 0.65P  
CASE 506BW  
ISSUE O

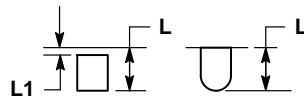
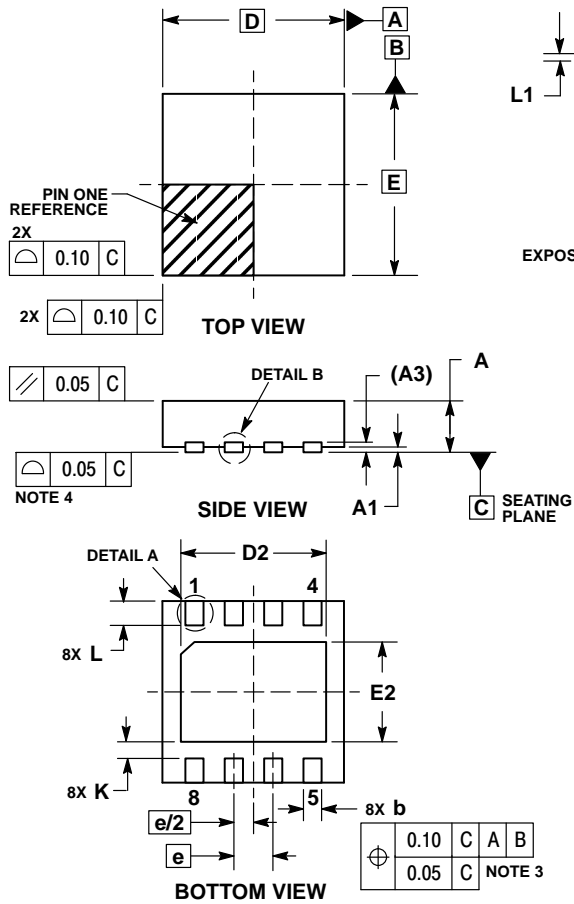

DETAIL A  
OPTIONAL  
CONSTRUCTIONS

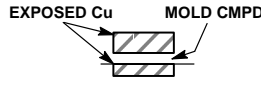

DETAIL B  
OPTIONAL  
CONSTRUCTIONS

NOTES:

1. DIMENSIONING AND TOLERANCING PER ASME Y14.5M, 1994.
2. CONTROLLING DIMENSION: MILLIMETERS.
3. DIMENSION b APPLIES TO PLATED TERMINAL AND IS MEASURED BETWEEN 0.15 AND 0.30mm FROM THE TERMINAL TIP.
4. COPLANARITY APPLIES TO THE EXPOSED PAD AS WELL AS THE TERMINALS.

MILLIMETERS		
DIM	MIN	MAX
A	0.80	1.00
A1	0.00	0.05
A3	0.20	REF
b	0.25	0.35
D	3.00	BSC
D2	2.30	2.50
E	3.00	BSC
E2	1.55	1.75
e	0.65	BSC
K	0.20	---
L	0.35	0.45
L1	0.00	0.15

RECOMMENDED  
SOLDERING FOOTPRINT\*

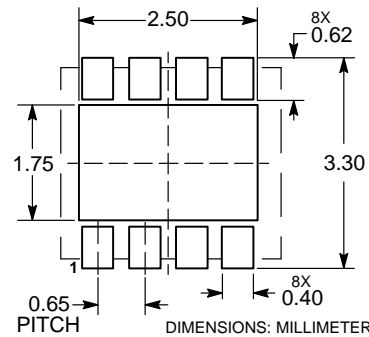

\*For additional information on our Pb-Free strategy and soldering details, please download the ON Semiconductor Soldering and Mounting Techniques Reference Manual, SOLDERRM/D.

PACKAGE DIMENSIONS

Micro8™  
CASE 846A-02  
ISSUE J

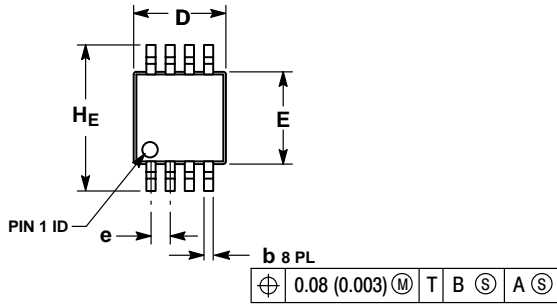

- NOTES:
1. DIMENSIONING AND TOLERANCING PER ANSI Y14.5M, 1982.
  2. CONTROLLING DIMENSION: MILLIMETER.
  3. DIMENSION A DOES NOT INCLUDE MOLD FLASH, PROTRUSIONS OR GATE BURRS. MOLD FLASH, PROTRUSIONS OR GATE BURRS SHALL NOT EXCEED 0.15 (0.006) PER SIDE.
  4. DIMENSION B DOES NOT INCLUDE INTERLEAD FLASH OR PROTRUSION. INTERLEAD FLASH OR PROTRUSION SHALL NOT EXCEED 0.25 (0.010) PER SIDE.
  5. 846A-01 OBSOLETE, NEW STANDARD 846A-02.

DIM	MILLIMETERS			INCHES		
	MIN	NOM	MAX	MIN	NOM	MAX
A	--	--	1.10	--	--	0.043
A1	0.05	0.08	0.15	0.002	0.003	0.006
b	0.25	0.33	0.40	0.010	0.013	0.016
c	0.13	0.18	0.23	0.005	0.007	0.009
D	2.90	3.00	3.10	0.114	0.118	0.122
E	2.90	3.00	3.10	0.114	0.118	0.122
e	0.65 BSC			0.026 BSC		
L	0.40	0.55	0.70	0.016	0.021	0.028
HE	4.75	4.90	5.05	0.187	0.193	0.199

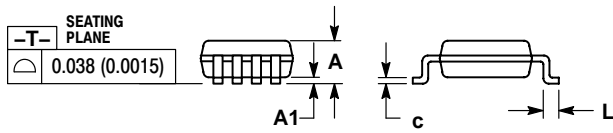

RECOMMENDED  
SOLDERING FOOTPRINT\*

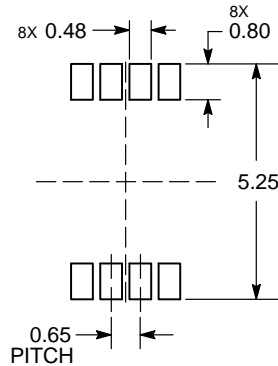

DIMENSION: MILLIMETERS

\*For additional information on our Pb-Free strategy and soldering details, please download the ON Semiconductor Soldering and Mounting Techniques Reference Manual, SOLDERRM/D.

PACKAGE DIMENSIONS

SOIC-8 NB  
CASE 751-07  
ISSUE AK

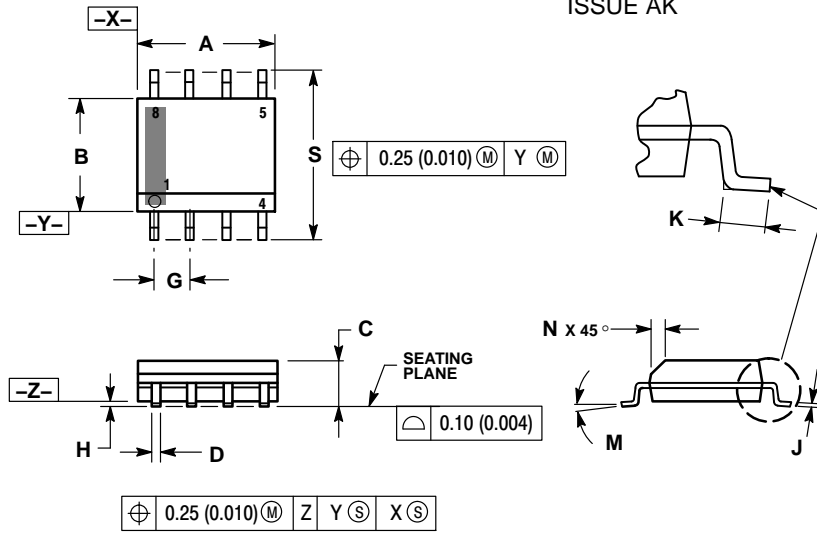

- NOTES:
1. DIMENSIONING AND TOLERANCING PER ANSI Y14.5M, 1982.
  2. CONTROLLING DIMENSION: MILLIMETER.
  3. DIMENSION A AND B DO NOT INCLUDE MOLD PROTRUSION.
  4. MAXIMUM MOLD PROTRUSION 0.15 (0.006) PER SIDE.
  5. DIMENSION D DOES NOT INCLUDE DAMBAR PROTRUSION. ALLOWABLE DAMBAR PROTRUSION SHALL BE 0.127 (0.005) TOTAL IN EXCESS OF THE D DIMENSION AT MAXIMUM MATERIAL CONDITION.
  6. 751-01 THRU 751-06 ARE OBSOLETE. NEW STANDARD IS 751-07.

DIM	MILLIMETERS		INCHES	
	MIN	MAX	MIN	MAX
A	4.80	5.00	0.189	0.197
B	3.80	4.00	0.150	0.157
C	1.35	1.75	0.053	0.069
D	0.33	0.51	0.013	0.020
G	1.27 BSC		0.050 BSC	
H	0.10	0.25	0.004	0.010
J	0.19	0.25	0.007	0.010
K	0.40	1.27	0.016	0.050
M	0°	8°	0°	8°
N	0.25	0.50	0.010	0.020
S	5.80	6.20	0.228	0.244

SOLDERING FOOTPRINT\*

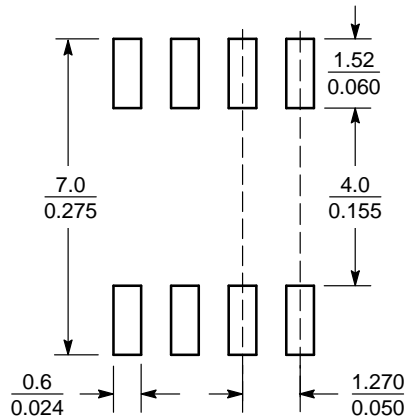

SCALE 6:1 ( $\frac{\text{mm}}{\text{inches}}$ )

\*For additional information on our Pb-Free strategy and soldering details, please download the ON Semiconductor Soldering and Mounting Techniques Reference Manual, SOLDERRM/D.

# NCS333, NCV333, NCS2333, NCV2333, NCS4333, NCV4333

## PACKAGE DIMENSIONS

### SOIC-14 NB CASE 751A-03 ISSUE K

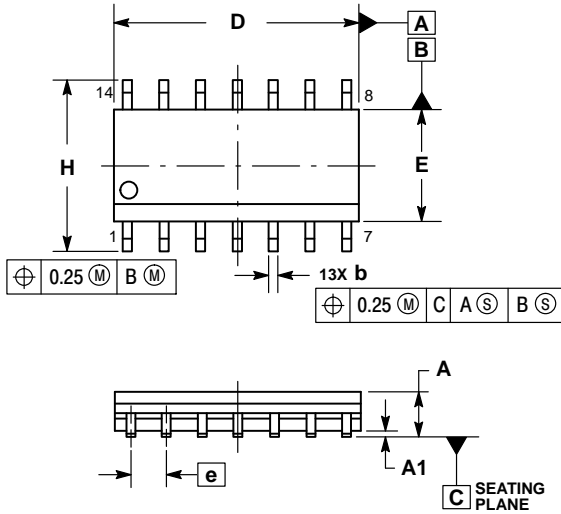

#### NOTES:

1. DIMENSIONING AND TOLERANCING PER ASME Y14.5M, 1994.
2. CONTROLLING DIMENSION: MILLIMETERS.
3. DIMENSION b DOES NOT INCLUDE DAMBAR PROTRUSION. ALLOWABLE PROTRUSION SHALL BE 0.13 TOTAL IN EXCESS OF AT MAXIMUM MATERIAL CONDITION.
4. DIMENSIONS D AND E DO NOT INCLUDE MOLD PROTRUSIONS.
5. MAXIMUM MOLD PROTRUSION 0.15 PER SIDE.

DIM	MILLIMETERS		INCHES	
	MIN	MAX	MIN	MAX
A	1.35	1.75	0.054	0.068
A1	0.10	0.25	0.004	0.010
A3	0.19	0.25	0.008	0.010
b	0.35	0.49	0.014	0.019
D	8.55	8.75	0.337	0.344
E	3.80	4.00	0.150	0.157
e	1.27 BSC		0.050 BSC	
H	5.80	6.20	0.228	0.244
h	0.25	0.50	0.010	0.019
L	0.40	1.25	0.016	0.049
M	0°	7°	0°	7°

### SOLDERING FOOTPRINT\*

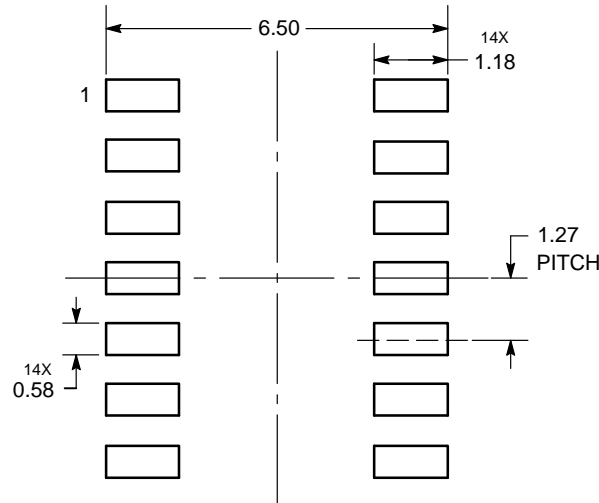

DIMENSIONS: MILLIMETERS

\*For additional information on our Pb-Free strategy and soldering details, please download the ON Semiconductor Soldering and Mounting Techniques Reference Manual, SOLDERRM/D.

ON Semiconductor and are trademarks of Semiconductor Components Industries, LLC dba ON Semiconductor or its subsidiaries in the United States and/or other countries. ON Semiconductor owns the rights to a number of patents, trademarks, copyrights, trade secrets, and other intellectual property. A listing of ON Semiconductor's product/patent coverage may be accessed at [www.onsemi.com/site/pdf/Patent-Marketing.pdf](http://www.onsemi.com/site/pdf/Patent-Marketing.pdf). ON Semiconductor reserves the right to make changes without further notice to any products herein. ON Semiconductor makes no warranty, representation or guarantee regarding the suitability of its products for any particular purpose, nor does ON Semiconductor assume any liability arising out of the application or use of any product or circuit, and specifically disclaims any and all liability, including without limitation special, consequential or incidental damages. Buyer is responsible for its products and applications using ON Semiconductor products, including compliance with all laws, regulations and safety requirements or standards, regardless of any support or applications information provided by ON Semiconductor. "Typical" parameters which may be provided in ON Semiconductor data sheets and/or specifications can and do vary in different applications and actual performance may vary over time. All operating parameters, including "Typicals" must be validated for each customer application by customer's technical experts. ON Semiconductor does not convey any license under its patent rights nor the rights of others. ON Semiconductor products are not designed, intended, or authorized for use as a critical component in life support systems or any FDA Class 3 medical devices or medical devices with a same or similar classification in a foreign jurisdiction or any devices intended for implantation in the human body. Should Buyer purchase or use ON Semiconductor products for any such unintended or unauthorized application, Buyer shall indemnify and hold ON Semiconductor and its officers, employees, subsidiaries, affiliates, and distributors harmless against all claims, costs, damages, and expenses, and reasonable attorney fees arising out of, directly or indirectly, any claim of personal injury or death associated with such unintended or unauthorized use, even if such claim alleges that ON Semiconductor was negligent regarding the design or manufacture of the part. ON Semiconductor is an Equal Opportunity/Affirmative Action Employer. This literature is subject to all applicable copyright laws and is not for resale in any manner.

### PUBLICATION ORDERING INFORMATION

**LITERATURE FULFILLMENT:**  
Literature Distribution Center for ON Semiconductor  
19521 E. 32nd Pkwy, Aurora, Colorado 80011 USA  
Phone: 303-675-2175 or 800-344-3860 Toll Free USA/Canada  
Fax: 303-675-2176 or 800-344-3867 Toll Free USA/Canada  
Email: [orderlit@onsemi.com](mailto:orderlit@onsemi.com)

**N. American Technical Support:** 800-282-9855 Toll Free  
USA/Canada  
**Europe, Middle East and Africa Technical Support:**  
Phone: 421 33 790 2910  
**Japan Customer Focus Center**  
Phone: 81-3-5817-1050

**ON Semiconductor Website:** [www.onsemi.com](http://www.onsemi.com)  
**Order Literature:** <http://www.onsemi.com/orderlit>

For additional information, please contact your local Sales Representative



# Mouser Electronics

Authorized Distributor

Click to View Pricing, Inventory, Delivery & Lifecycle Information:

[ON Semiconductor:](#)

[NCS333SQ3T2G](#)