

# NCP4586

## 150 mA, Low Noise, Low Dropout Regulator

The NCP4586 is a CMOS 150 mA low dropout linear with low noise, high ripple rejection, low dropout, high output voltage accuracy and low supply current. The device is available in three configurations: enable high, enable low and enable high plus auto-discharge. Small packages allow mounting on high density PCBs. This is an excellent general purpose regulator, well suited to many applications.

### Features

- Operating Input Voltage Range: 1.7 V to 6.5 V
- Output Voltage Range: 1.2 to 5.0 V (available in 0.1 V steps)
- Very Low Dropout: 320 mV Typ. at 150 mA
- $\pm 1\%$  Output Voltage Accuracy ( $V_{OUT} > 2\text{ V}$ ,  $T_J = 25^\circ\text{C}$ )
- High PSRR: 80 dB at 1 kHz
- Current Fold Back Protection
- Stable with a 0.47  $\mu\text{F}$  Ceramic Capacitors
- Available in 1.0 x 1.0 UDFN, SC-82AB and SOT23-5 Package
- These are Pb-Free Devices

### Typical Applications

- Battery Powered Equipment
- Portable Communication Equipment
- Cameras, MP3 Players and Camcorder
- High Stability Voltage Reference

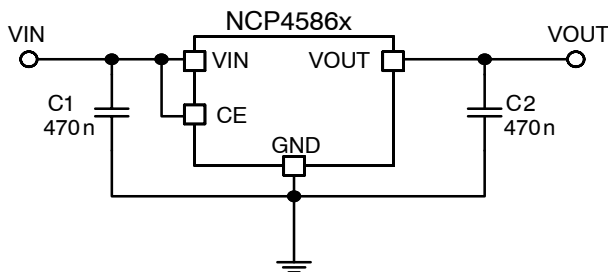

Figure 1. Typical Application Schematic



**ON Semiconductor™**

<http://onsemi.com>

### MARKING DIAGRAMS

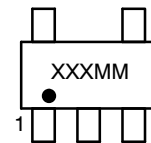
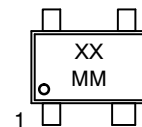
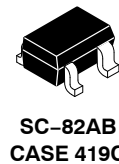
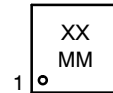

XX, XXX = Specific Product Code  
MM = Lot Number

### ORDERING INFORMATION

See detailed ordering and shipping information in the package dimensions section on page 15 of this data sheet.

# NCP4586

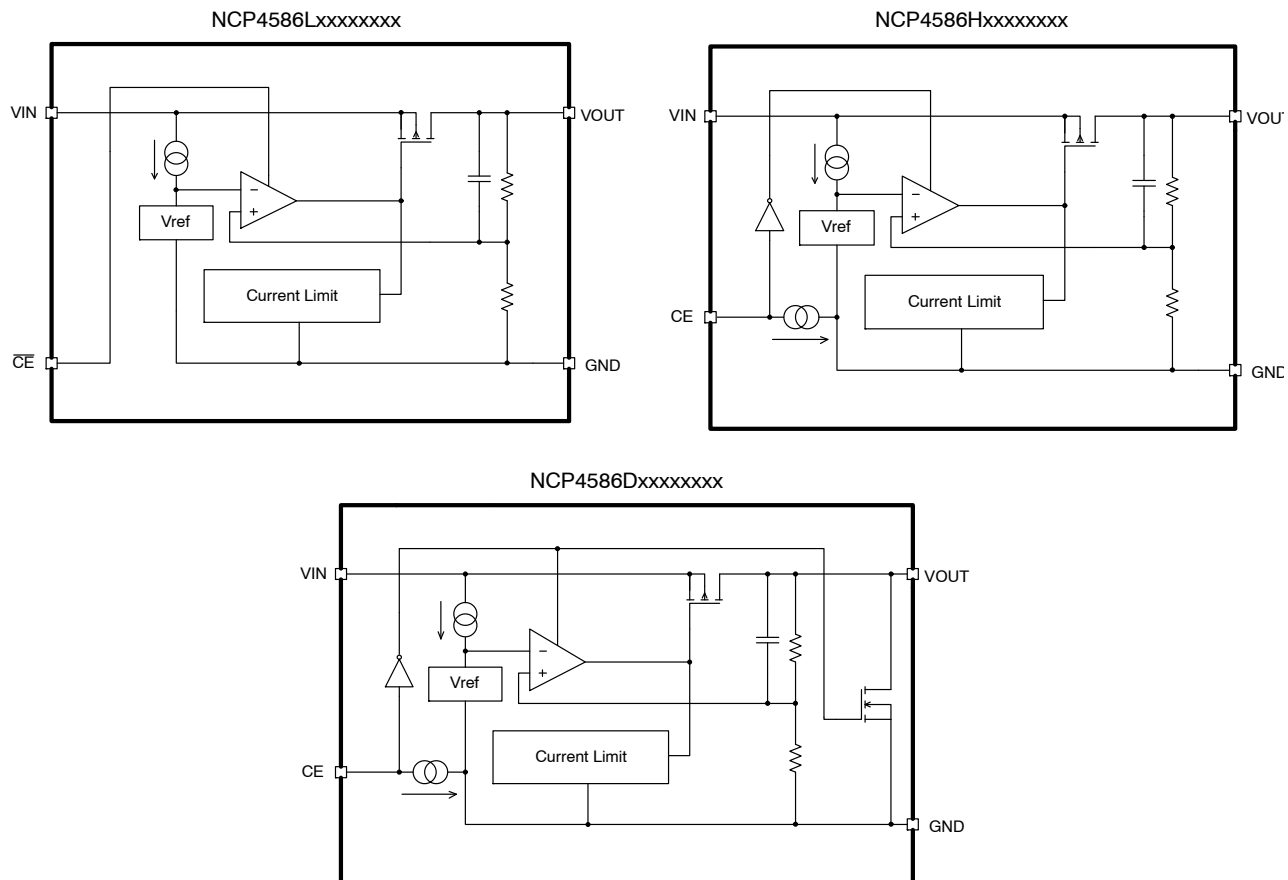

Figure 2. Simplified Schematic Block Diagram

## PIN FUNCTION DESCRIPTION

Pin No. UDFN4	Pin No. SC82-AB	Pin No. SOT23-5	Pin Name	Description
4	4	1	VIN	Input pin
2	2	2	GND	Ground
3	1	3	$\overline{CE}/CE$	Chip enable pin ("L" active / "H" active)
1	3	5	VOUT	Output pin
-	-	4	NC	No connection

# NCP4586

## ABSOLUTE MAXIMUM RATINGS

Rating	Symbol	Value	Unit
Input Voltage (Note 1)	$V_{IN}$	7	V
Output Voltage	$V_{OUT}$	-0.3 to $V_{IN} + 0.3$	V
Chip Enable Input	$V_{CE}$	-0.3 to 7	V
Output Current	$I_{OUT}$	200	mA
Power Dissipation UDFN4	$P_D$	400	mW
Power Dissipation SC-82AB		380	
Power Dissipation SOT23-5		420	
Maximum Junction Temperature	$T_{J(MAX)}$	+150	°C
Operating Ambient Temperature	$T_A$	-40 to +85	°C
Storage Temperature	$T_{STG}$	-55 to +125	°C
ESD Capability, Human Body Model (Note 2)	$ESD_{HBM}$	2000	V
ESD Capability, Machine Model (Note 2)	$ESD_{MM}$	200	V

Stresses exceeding Maximum Ratings may damage the device. Maximum Ratings are stress ratings only. Functional operation above the Recommended Operating Conditions is not implied. Extended exposure to stresses above the Recommended Operating Conditions may affect device reliability.

1. Refer to ELECTRICAL CHARACTERISTICS and APPLICATION INFORMATION for Safe Operating Area.
2. This device series incorporates ESD protection and is tested by the following methods:  
 ESD Human Body Model tested per AEC-Q100-002 (EIA/JESD22-A114)  
 ESD Machine Model tested per AEC-Q100-003 (EIA/JESD22-A115)  
 Latchup Current Maximum Rating tested per JEDEC standard: JESD78.

## THERMAL CHARACTERISTICS

Rating	Symbol	Value	Unit
Thermal Characteristics, UDFN4 Thermal Resistance, Junction-to-Air	$R_{\theta JA}$	250	°C/W
Thermal Characteristics, SOT23-5 Thermal Resistance, Junction-to-Air	$R_{\theta JA}$	238	°C/W
Thermal Characteristics, SC 82AB Thermal Resistance, Junction-to-Air	$R_{\theta JA}$	263	°C/W

# NCP4586

**ELECTRICAL CHARACTERISTICS**  $-40^{\circ}\text{C} \leq T_A \leq 85^{\circ}\text{C}$ ;  $V_{\text{IN}} = V_{\text{OUT(NOM)}} + 1\text{ V}$  or  $2.5\text{ V}$ , whichever is greater;  $I_{\text{OUT}} = 1\text{ mA}$ ,  $C_{\text{IN}} = C_{\text{OUT}} = 0.47\text{ }\mu\text{F}$ , unless otherwise noted. Typical values are at  $T_A = +25^{\circ}\text{C}$ .

Parameter	Test Conditions		Symbol	Min	Typ	Max	Unit
Operating Input Voltage			$V_{\text{IN}}$	1.7		6.5	V
Output Voltage	$T_A = +25^{\circ}\text{C}$	$V_{\text{OUT}} > 2\text{ V}$	$V_{\text{OUT}}$	x0.99		x1.01	V
		$V_{\text{OUT}} \leq 2\text{ V}$		-20		20	mV
	$-40^{\circ}\text{C} \leq T_A \leq 85^{\circ}\text{C}$	$V_{\text{OUT}} > 2\text{ V}$		x0.985		x1.015	V
		$V_{\text{OUT}} \leq 2\text{ V}$		-30		30	mV
Output Voltage Temp. Coefficient	$T_A = -40\text{ to }85^{\circ}\text{C}$				$\pm 20$		ppm/ $^{\circ}\text{C}$
Line Regulation	$V_{\text{IN}} = V_{\text{OUT}} + 0.5\text{ V}$ to $5\text{ V}$		$\text{LineReg}$		0.02	0.10	%/V
Load Regulation	$I_{\text{OUT}} = 1\text{ mA}$ to $150\text{ mA}$		$\text{LoadReg}$		10	30	mV
Dropout Voltage	$I_{\text{OUT}} = 150\text{ mA}$	$1.2\text{ V} \leq V_{\text{OUT}} < 1.5\text{ V}$	$V_{\text{DO}}$		0.67	1.00	V
		$1.5\text{ V} \leq V_{\text{OUT}} < 1.7\text{ V}$			0.54	0.81	
		$1.7\text{ V} \leq V_{\text{OUT}} < 2.0\text{ V}$			0.46	0.68	
		$2.0\text{ V} \leq V_{\text{OUT}} < 2.5\text{ V}$			0.41	0.60	
		$2.5\text{ V} \leq V_{\text{OUT}} < 4.0\text{ V}$			0.32	0.51	
		$4.0\text{ V} \leq V_{\text{OUT}}$			0.24	0.37	
Output Current			$I_{\text{OUT}}$	150			mA
Short Current Limit	$V_{\text{OUT}} = 0\text{ V}$		$I_{\text{SC}}$		40		mA
Quiescent Current	$I_{\text{OUT}} = 0\text{ mA}$		$I_{\text{Q}}$		38	58	$\mu\text{A}$
Standby Current	$V_{\text{CE}} = V_{\text{IN}}$ (L version), $V_{\text{CE}} = 0\text{ V}$ (H and D version), $T_A = 25^{\circ}\text{C}$		$I_{\text{STB}}$		0.1	1	$\mu\text{A}$
$\overline{\text{CE}}/\text{CE}$ Pin Threshold Voltage	$\overline{\text{CE}} / \text{CE}$ Input Voltage "H"		$V_{\text{CEH}}$	1.0			V
	$\overline{\text{CE}} / \text{CE}$ Input Voltage "L"		$V_{\text{CEL}}$			0.4	
CE Pull Down Current	H and D version		$I_{\text{PD}}$		0.4		$\mu\text{A}$
Power Supply Rejection Ratio	$V_{\text{IN}} = V_{\text{OUT}} + 1\text{ V}$ or $3.0\text{ V}$ whichever is higher, $I_{\text{OUT}} = 30\text{ mA}$ , $f = 1\text{ kHz}$		PSRR		80		dB
Output Noise Voltage	$V_{\text{OUT}} = 1.2\text{ V}$ , $I_{\text{OUT}} = 30\text{ mA}$ , $f = 10\text{ Hz}$ to $100\text{ kHz}$		$V_{\text{N}}$		30		$\mu\text{V}_{\text{rms}}$
Low Output N-ch Tr. On Resistance	D Version only, $V_{\text{IN}} = 4\text{ V}$ , $V_{\text{CE}} = 0\text{ V}$		$R_{\text{LOW}}$		30		$\Omega$

TYPICAL CHARACTERISTICS

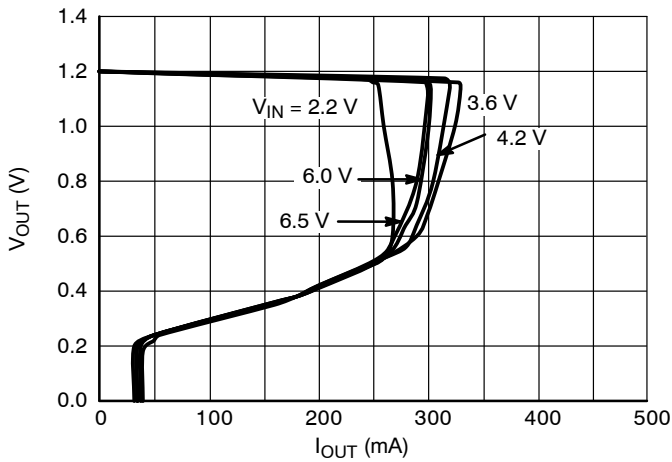

Figure 3. Output Voltage vs. Output Current  
1.2 V Version ( $T_A = 25^\circ\text{C}$ )

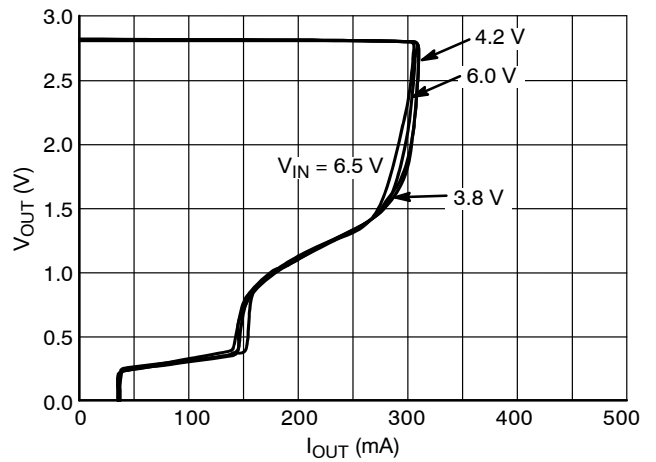

Figure 4. Output Voltage vs. Output Current  
2.8 V Version ( $T_A = 25^\circ\text{C}$ )

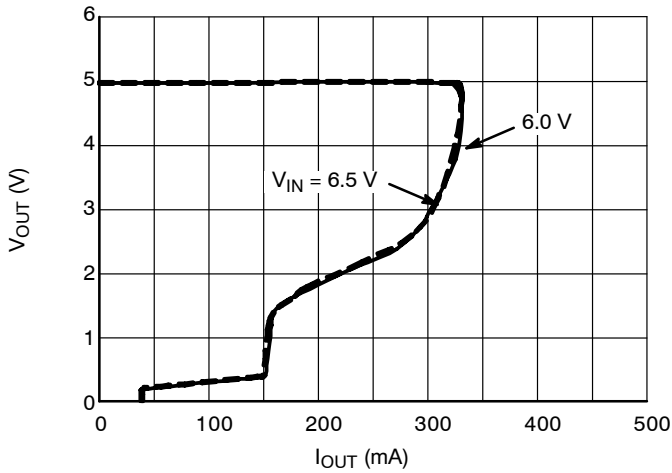

Figure 5. Output Voltage vs. Output Current  
5.0 V version ( $T_A = 25^\circ\text{C}$ )

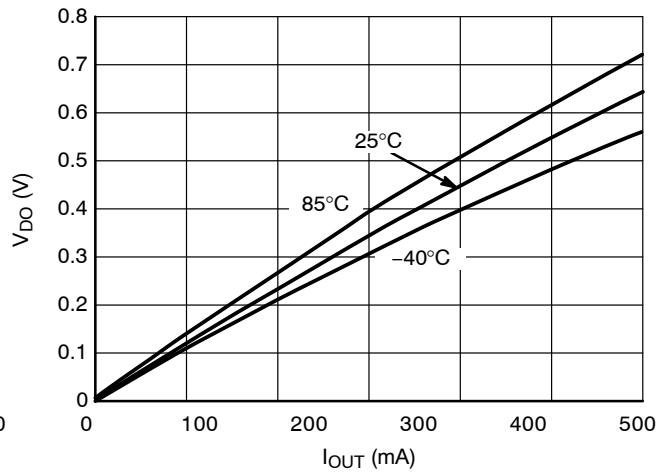

Figure 6. Dropout Voltage vs. Output Current  
1.2 V version

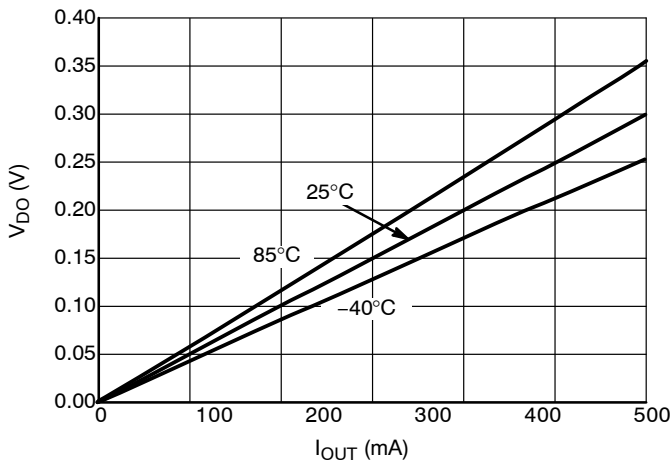

Figure 7. Dropout Voltage vs. Output Current  
2.8 V Version

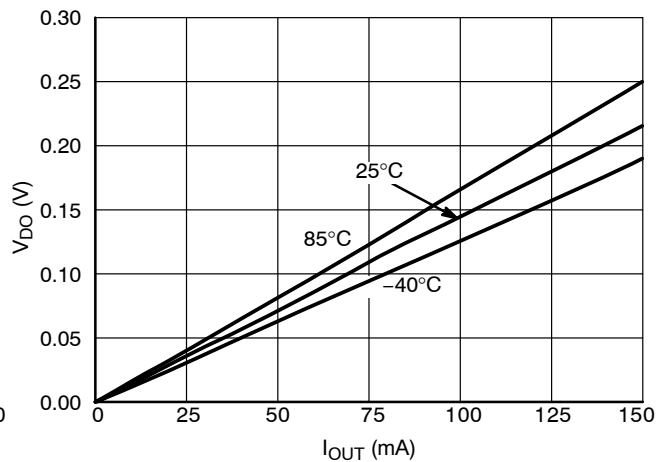

Figure 8. Dropout Voltage vs. Output Current  
5.0 V Version

TYPICAL CHARACTERISTICS

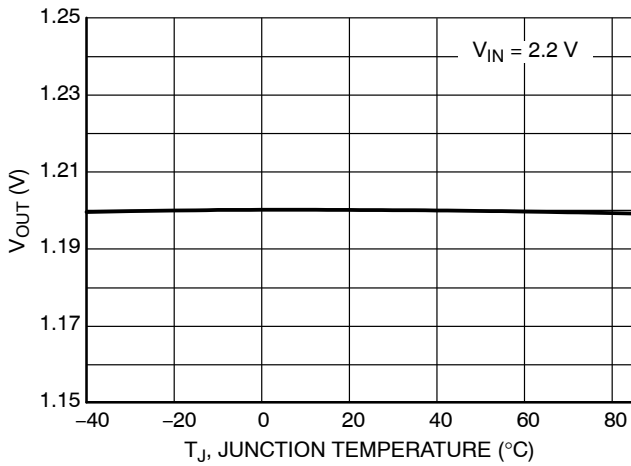

Figure 9. Output Voltage vs. Temperature, 1.2 V Version

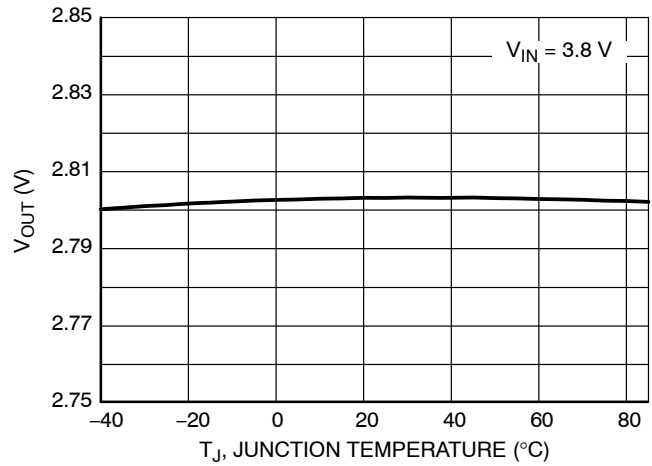

Figure 10. Output Voltage vs. Temperature, 2.8 V version

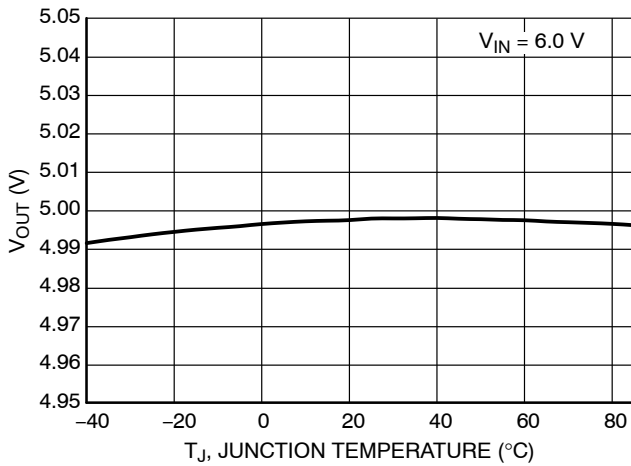

Figure 11. Output Voltage vs. Temperature, 5.0 V Version

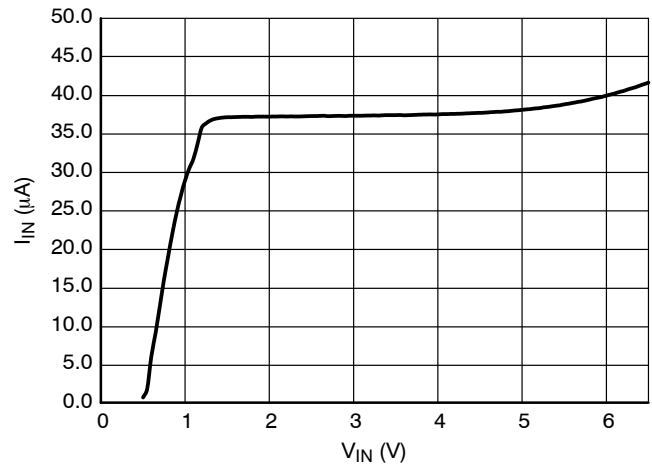

Figure 12. Supply Current vs. Input Voltage, 1.2 V Version

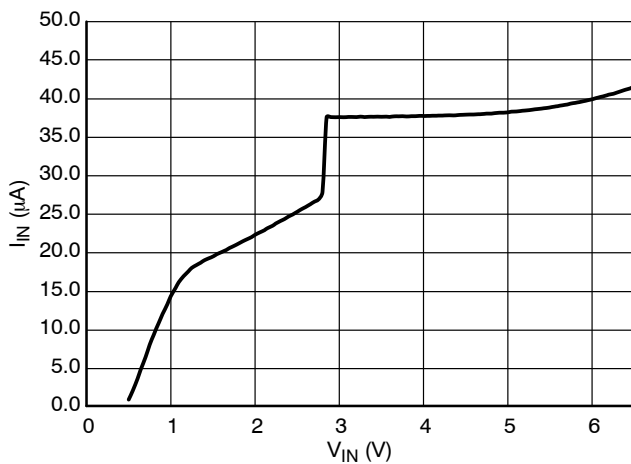

Figure 14. Supply Current vs. Input Voltage, 2.8 V Version

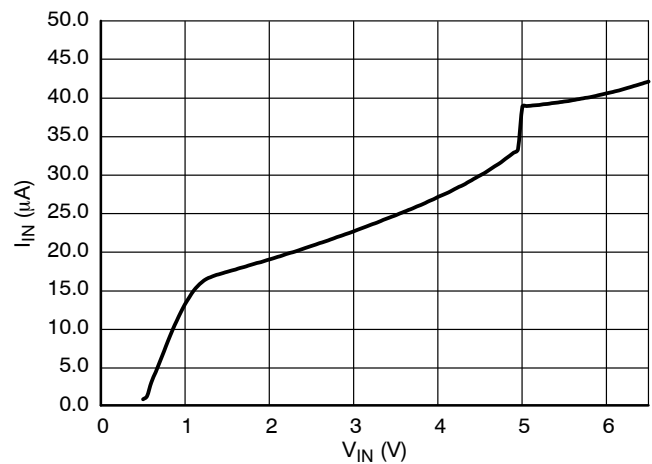

Figure 13. Supply Current vs. Input Voltage, 5.0 V version

TYPICAL CHARACTERISTICS

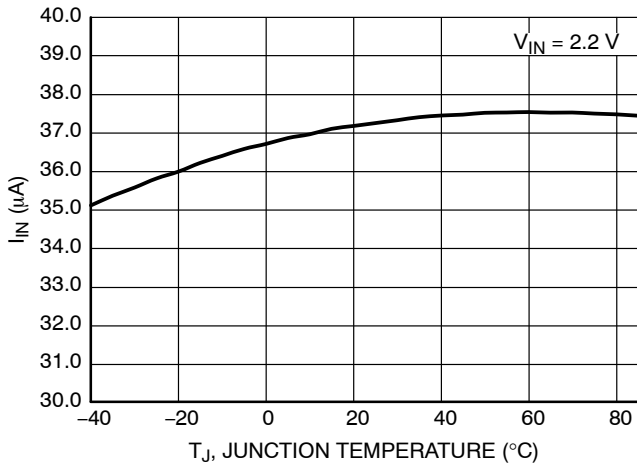

Figure 15. Supply Current vs. Temperature, 1.2 V Version

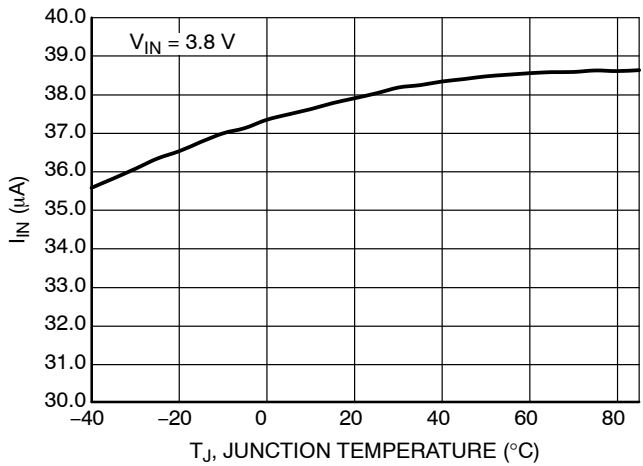

Figure 16. Supply Current vs. Temperature, 2.8 V Version

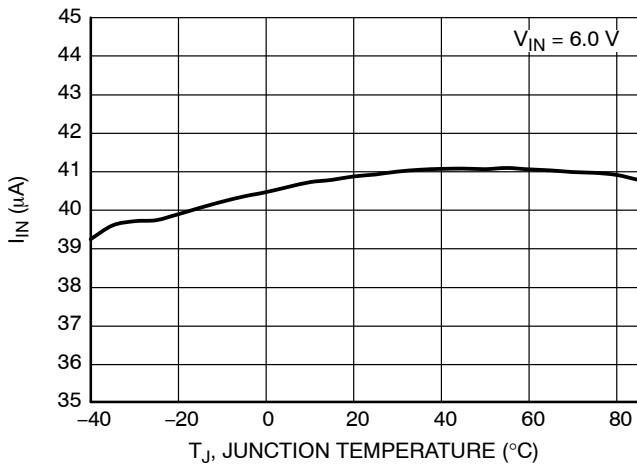

Figure 17. Supply Current vs. Temperature, 5.0 V Version

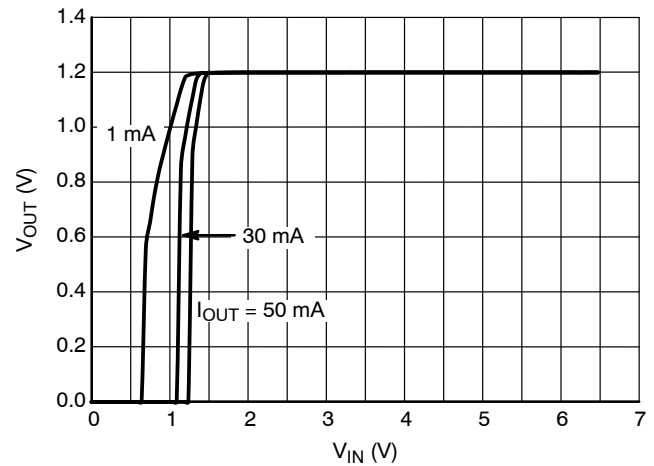

Figure 18. Output Voltage vs. Input Voltage, 1.2 V Version

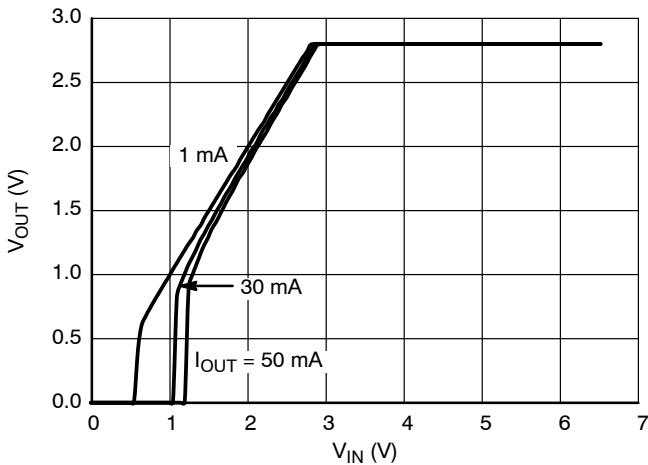

Figure 19. Output Voltage vs. Input Voltage, 2.8 V Version

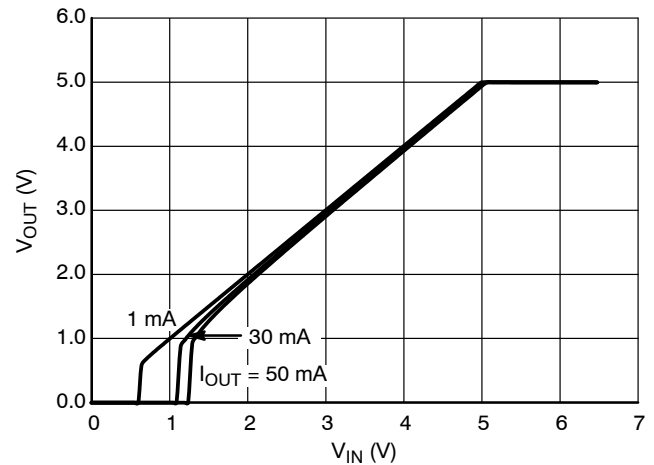

Figure 20. Output Voltage vs. Input Voltage, 5.0 V Version

TYPICAL CHARACTERISTICS

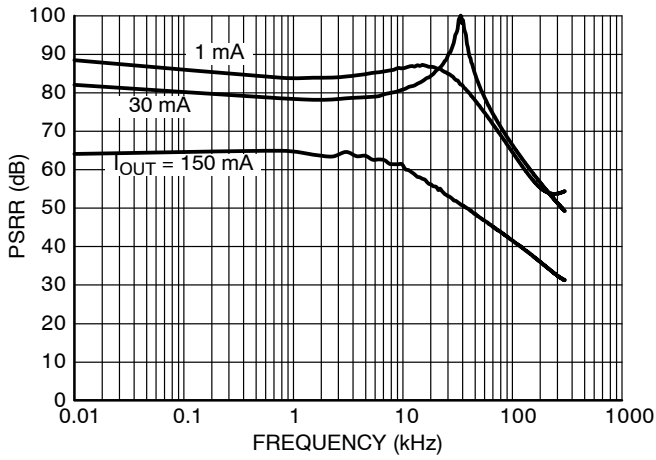

Figure 21. PSRR, 1.2 V Version

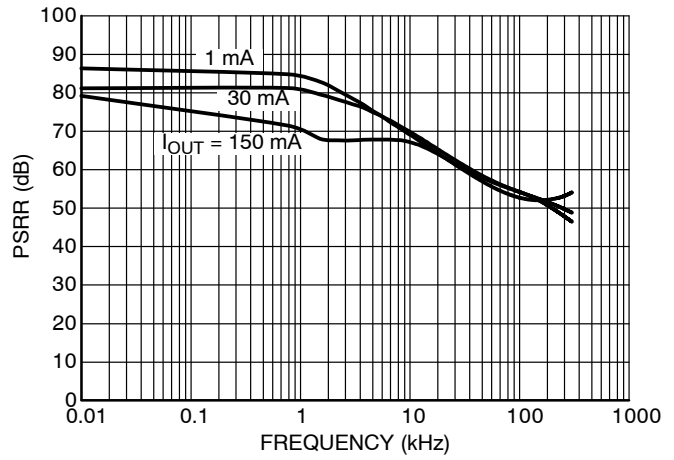

Figure 22. PSRR, 2.8 V Version

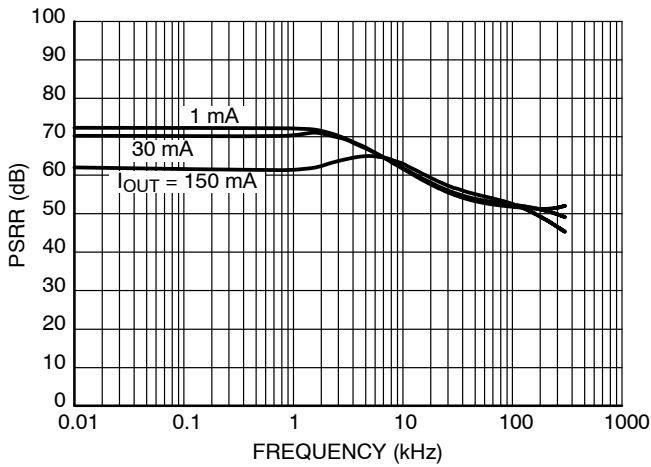

Figure 23. PSRR, 5.0 V Version

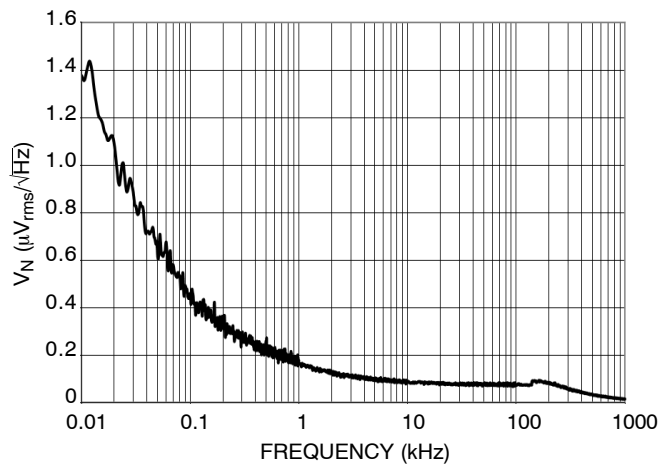

Figure 24. Output Voltage Noise, 1.2 V Version

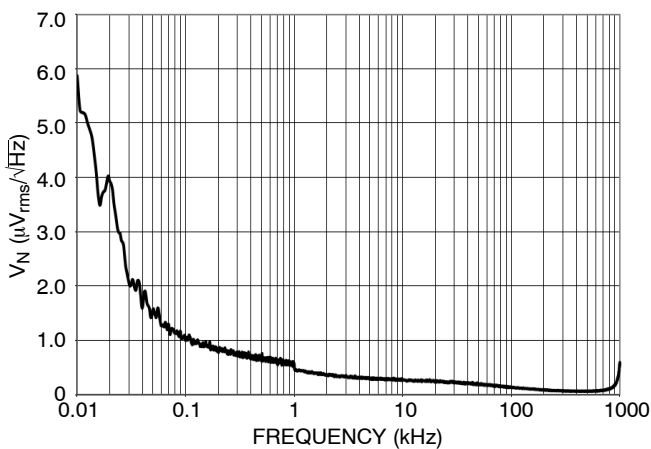

Figure 25. Output Voltage Noise, 2.8 V Version

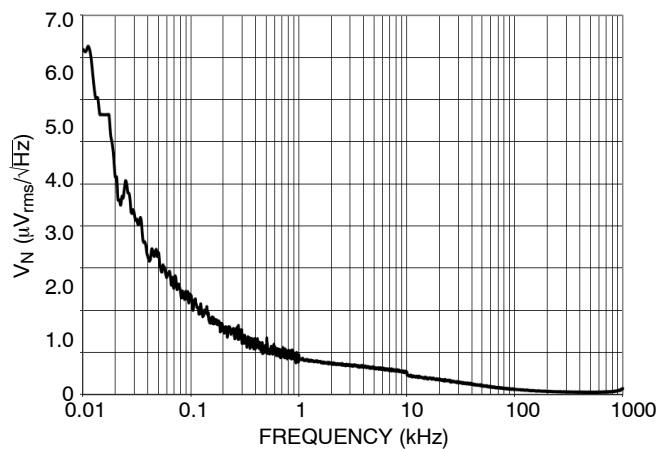
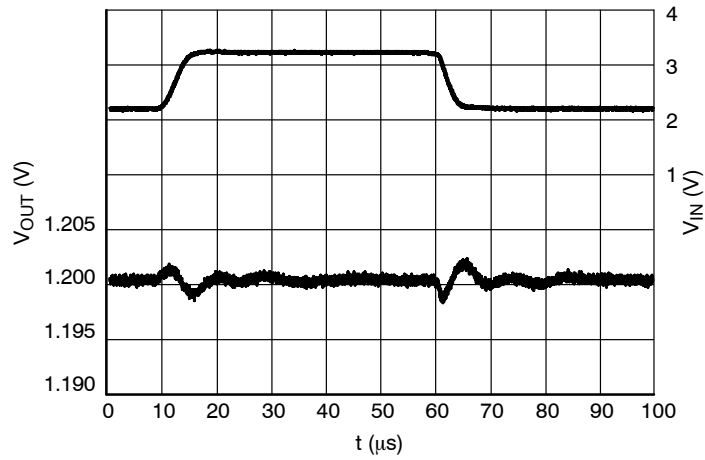

Figure 26. Output Voltage Noise, 5.0 V Version



# NCP4586

## TYPICAL CHARACTERISTICS



**Figure 27. Line Transients, 1.2 V Version,  
 $t_R = t_F = 5 \mu s$ ,  $I_{OUT} = 30 \text{ mA}$**

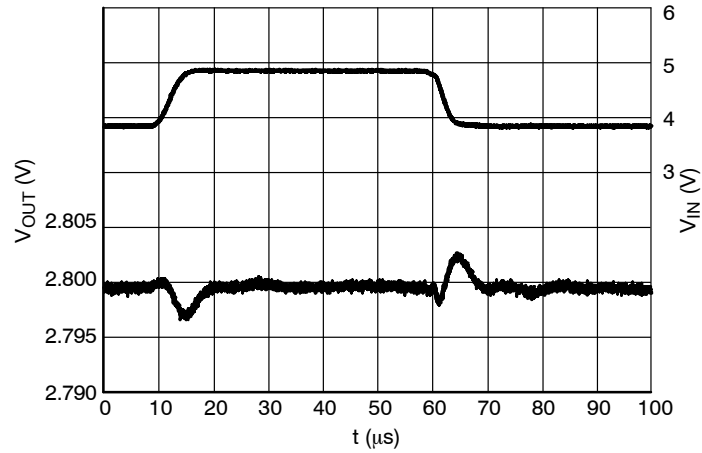

**Figure 28. Line Transients, 2.8 V Version,  
 $t_R = t_F = 5 \mu s$ ,  $I_{OUT} = 30 \text{ mA}$**

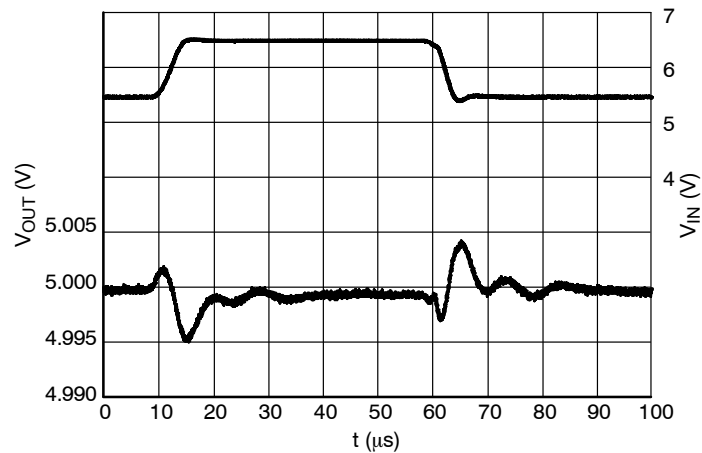

**Figure 29. Line Transients, 5.0 V Version,  $t_R = t_F = 5 \mu s$ ,  $I_{OUT} = 30 \text{ mA}$**

# NCP4586

## TYPICAL CHARACTERISTICS

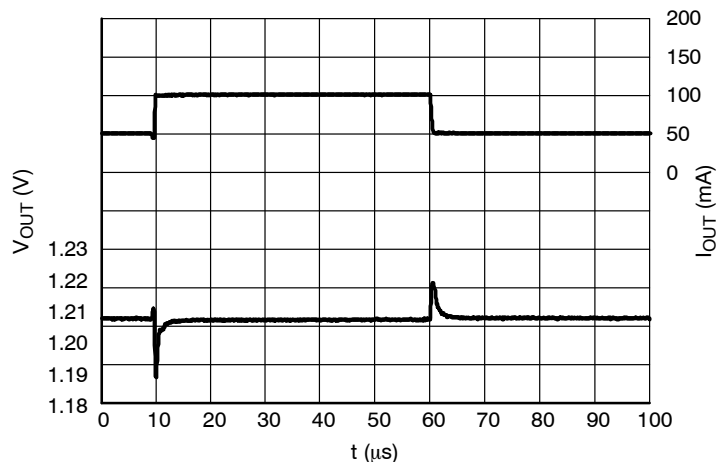

**Figure 30. Load Transients, 1.2 V Version,  
 $I_{OUT} = 50 - 100 \text{ mA}$ ,  $t_R = t_F = 0.5 \mu\text{s}$ ,  $V_{IN} = 2.2 \text{ V}$**

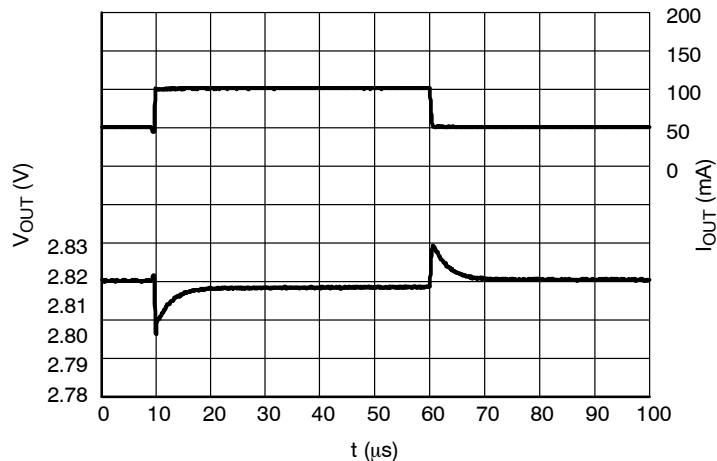

**Figure 31. Load Transients, 2.8 V Version,  
 $I_{OUT} = 50 - 100 \text{ mA}$ ,  $t_R = t_F = 0.5 \mu\text{s}$ ,  $V_{IN} = 3.8 \text{ V}$**

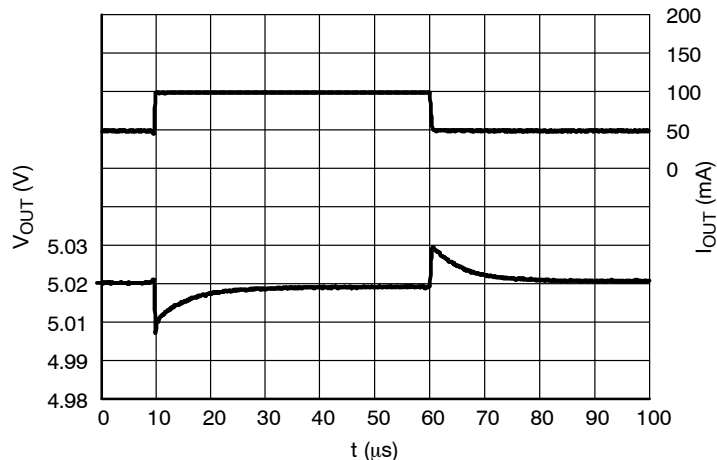

**Figure 32. Load Transients, 5.0 V Version,  
 $I_{OUT} = 50 - 100 \text{ mA}$ ,  $t_R = t_F = 0.5 \mu\text{s}$ ,  $V_{IN} = 6.0 \text{ V}$**

# NCP4586

## TYPICAL CHARACTERISTICS

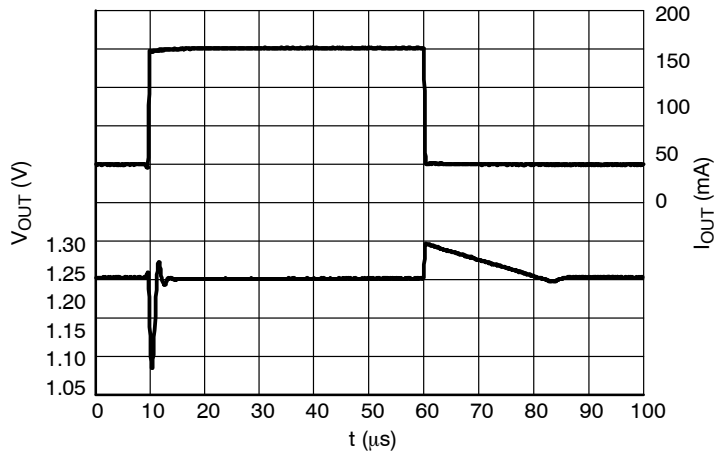

**Figure 33. Load Transients, 1.2 V Version,  
 $I_{OUT} = 1 - 150$  mA,  $t_R = t_F = 0.5$   $\mu$ s,  $V_{IN} = 2.2$  V**

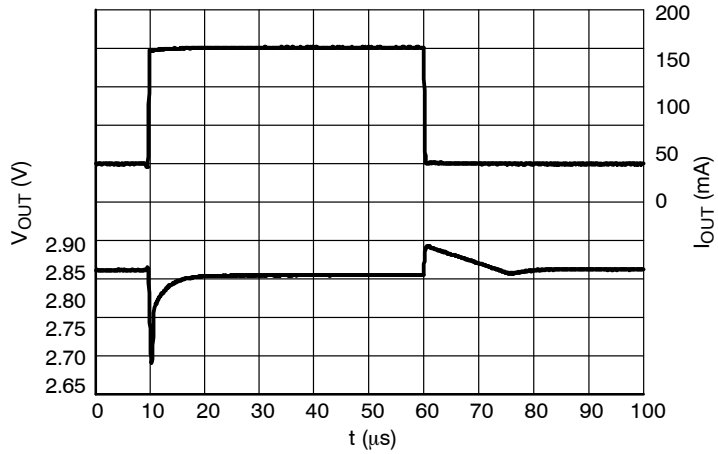

**Figure 34. Load Transients, 2.8 V Version,  
 $I_{OUT} = 1 - 150$  mA,  $t_R = t_F = 0.5$   $\mu$ s,  $V_{IN} = 3.8$  V**

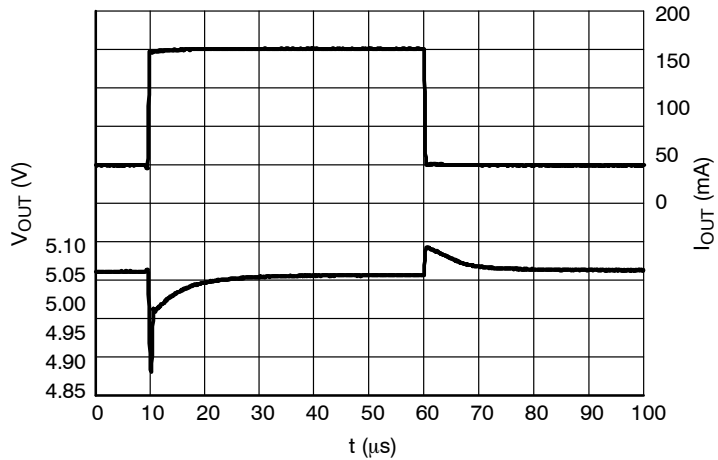

**Figure 35. Load Transients, 5.0 V Version,  
 $I_{OUT} = 1 - 150$  mA,  $t_R = t_F = 0.5$   $\mu$ s,  $V_{IN} = 6.0$  V**

# NCP4586

## TYPICAL CHARACTERISTICS

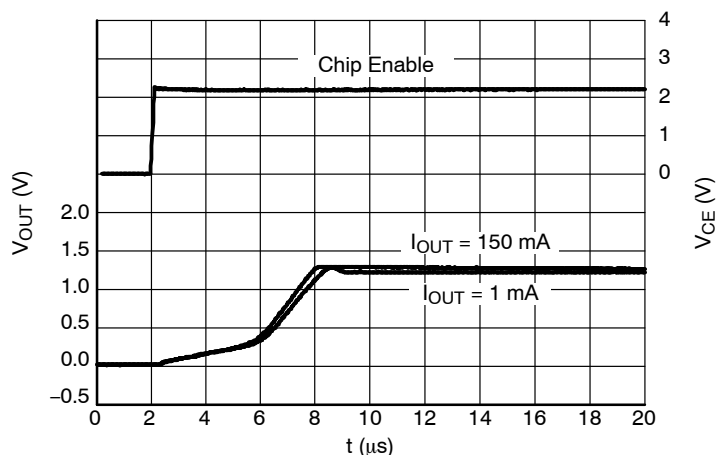

Figure 36. Start-up, 1.2 V Version,  $V_{\text{IN}} = 2.2 \text{ V}$

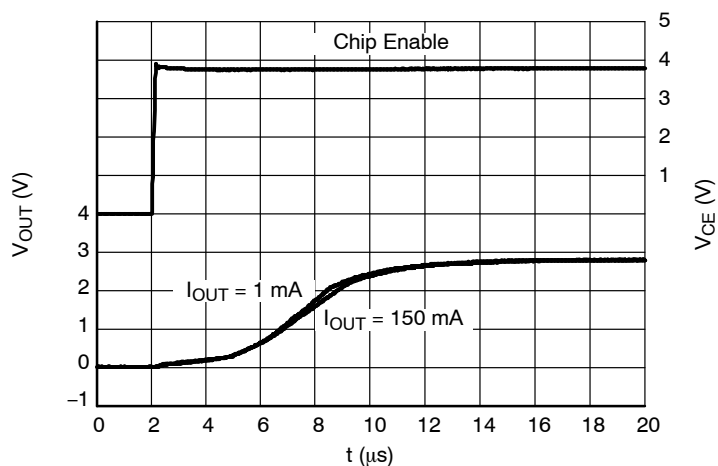

Figure 37. Start-up, 2.8 V Version,  $V_{\text{IN}} = 3.8 \text{ V}$

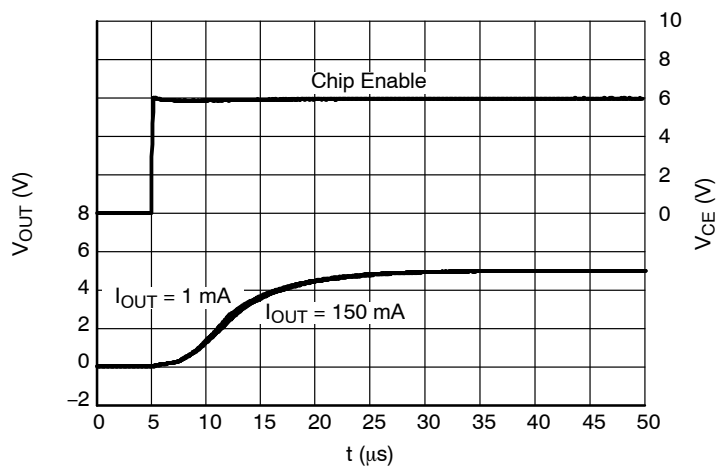

Figure 38. Start-up, 5.0 V Version,  $V_{\text{IN}} = 6.0 \text{ V}$

# NCP4586

## TYPICAL CHARACTERISTICS

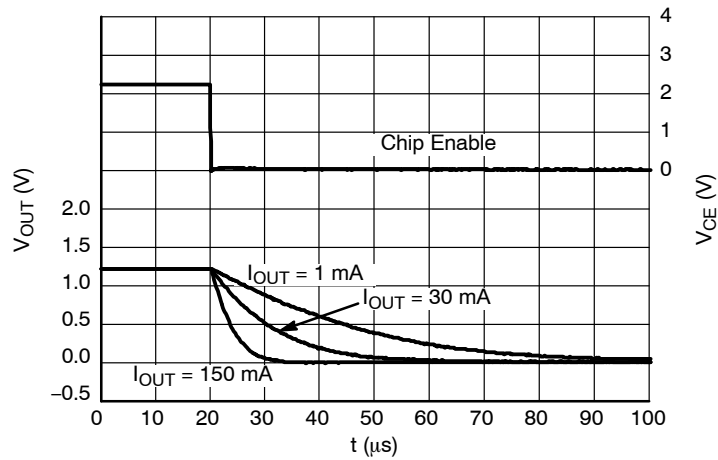

Figure 39. Shutdown, 1.2 V Version D,  
 $V_{IN} = 2.2 \text{ V}$

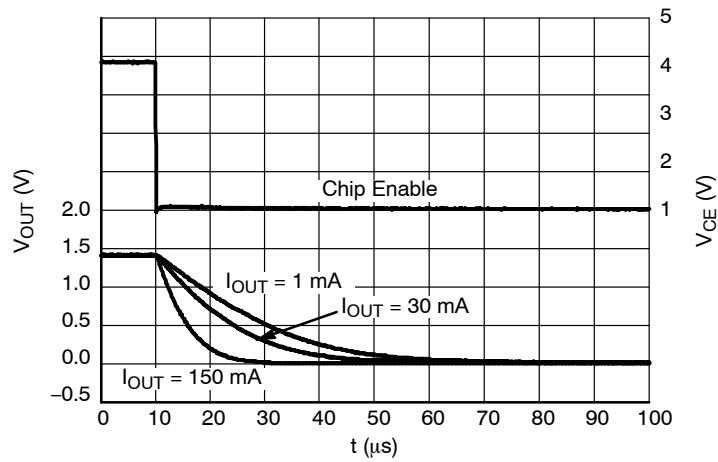

Figure 40. Shutdown, 2.8 V Version D,  
 $V_{IN} = 3.8 \text{ V}$

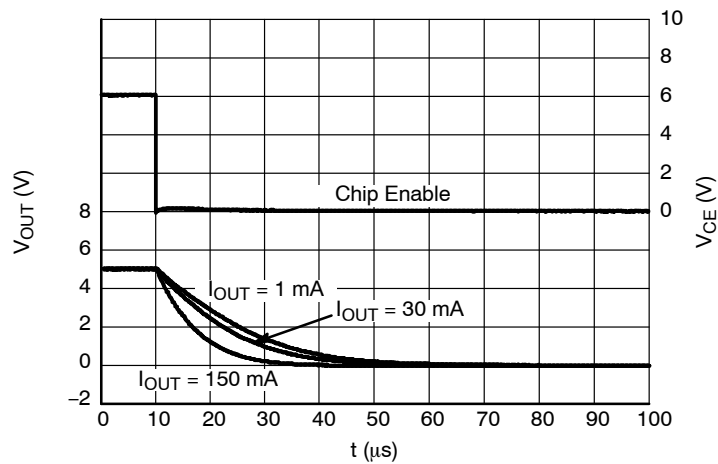

Figure 41. Shutdown, 5.0 V version D,  
 $V_{IN} = 6.0 \text{ V}$

## APPLICATION INFORMATION

A typical application circuit for NCP4586 series is shown in Figure 42.

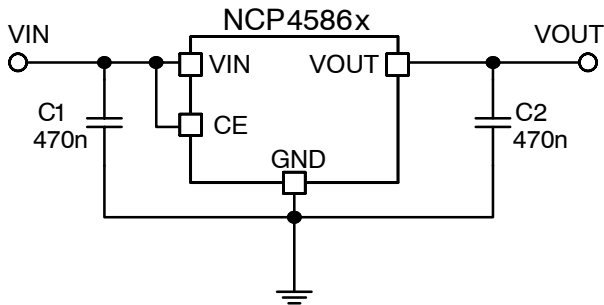

Figure 42. Typical Application Schematic

#### Input Decoupling Capacitor (C1)

A 470 nF ceramic input decoupling capacitor should be connected as close as possible to the input and ground pin of the NCP4586. Higher values and lower ESR improves line transient response.

#### Output Decoupling Capacitor (C2)

A 470 nF or larger ceramic output decoupling capacitor is sufficient to achieve stable operation of the IC. If a tantalum capacitor is used, and its ESR is high, loop oscillation may result. The capacitors should be connected as close as possible to the output and ground pins. Larger values and lower ESR improves dynamic parameters.

#### Enable Operation

The Enable pin  $\overline{CE}$  or CE may be used for turning the regulator on and off. Control polarity is dependent on

version of IC. Active high or low versions are available; please see the ordering information table. The Enable pin has an internal pull down current source for versions H and D. If the enable function is not needed connect the  $\overline{CE}$  pin to ground for version L or connect the CE pin to VIN for versions H and D.

#### Output Discharger

The D version includes a transistor between VOUT and GND that is used for faster discharging of the output capacitor. This function is activated when the IC goes into disable mode.

#### Thermal

As power across the IC increases, it might become necessary to provide some thermal relief. The maximum power dissipation supported by the device is dependent upon board design and layout. Mounting pad configuration on the PCB, the board material, and also the ambient temperature affect the rate of temperature rise for the part. That is to say, when the device has good thermal conductivity through the PCB, the junction temperature will be relatively low with high power dissipation applications.

#### PCB Layout

Make VIN and GND line sufficient. If their impedance is high, noise pickup or unstable operation may result. Connect capacitors C1 and C2 as close as possible to the IC, and make wiring as short as possible.

# NCP4586

## ORDERING INFORMATION

Device	Nominal Output Voltage	Description	Marking	Package	Shipping <sup>†</sup>
NCP4586DSQ12T1G	1.2 V	Enable High, Auto discharge	LA	SC82AB (Pb-Free)	3000 / Tape & Reel
NCP4586DSQ18T1G	1.8 V		LG		
NCP4586DSQ28T1G	2.8 V		MH		
NCP4586DSQ30T1G	3.0 V		NA		
NCP4586DSQ33T1G	3.3 V		ND		
NCP4586DSQ50T1G	5.0 V		QA		
NCP4586DMU12TCG	1.2 V		VA	UDFN4 (Pb-Free)	10000 / Tape & Reel
NCP4586DMU14TCG	1.4 V		VC		
NCP4586DMU15TCG	1.5 V		VD		
NCP4586DMU18TCG	1.8 V		VG		
NCP4586DMU25TCG	2.5 V		VQ		
NCP4586DMU28TCG	2.8 V		VT		
NCP4586DMU30TCG	3.0 V		VW		
NCP4586DMU33TCG	3.3 V		VZ		
NCP4586DMU50TCG	5.0 V		WS		
NCP4586DSN12T1G	1.2 V		H2A		
NCP4586DSN18T1G	1.8 V		H2G		
NCP4586DSN28T1G	2.8 V		H2T		
NCP4586DSN30T1G	3.0 V		H2W		
NCP4586DSN33T1G	3.3 V		H2Z		
NCP4586DSN50T1G	5.0 V		J2S		

<sup>†</sup>For information on tape and reel specifications, including part orientation and tape sizes, please refer to our Tape and Reel Packaging Specifications Brochure, BRD8011/D.

NOTE: To order other package and voltage variants, please contact your ON Semiconductor sales representative.

# NCP4586

## PACKAGE DIMENSIONS

UDFN4 1.0x1.0, 0.65P  
CASE 517BR-01  
ISSUE O

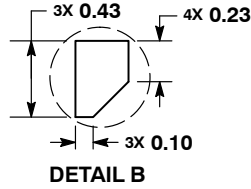
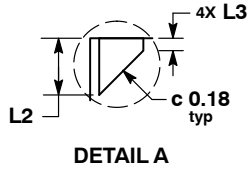
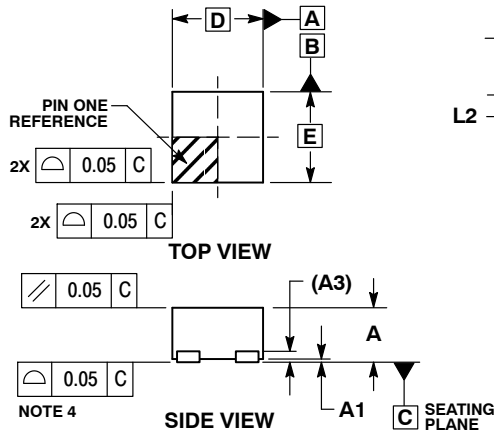

**NOTES:**

1. DIMENSIONING AND TOLERANCING PER ASME Y14.5M, 1994.
2. CONTROLLING DIMENSION: MILLIMETERS.
3. DIMENSION b APPLIES TO PLATED TERMINAL AND IS MEASURED BETWEEN 0.15 AND 0.20 mm FROM TERMINAL.
4. COPLANARITY APPLIES TO THE EXPOSED PAD AS WELL AS THE TERMINALS.

MILLIMETERS		
DIM	MIN	MAX
A	---	0.60
A1	0.00	0.05
A3	0.10 REF	
b	0.20	0.30
D	1.00 BSC	
D2	0.43	0.53
E	1.00 BSC	
e	0.65 BSC	
L	0.20	0.30
L2	0.27	0.37
L3	0.02	0.12

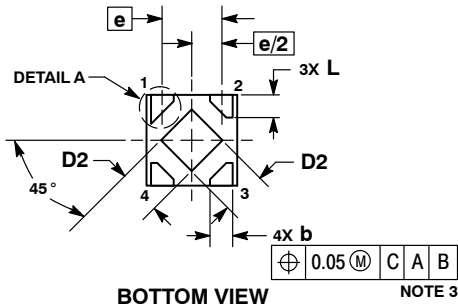

**RECOMMENDED MOUNTING FOOTPRINT\***

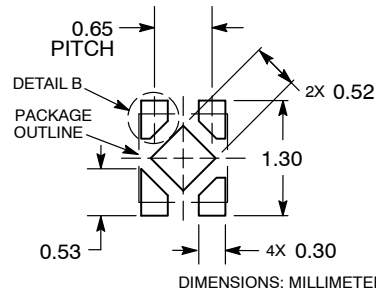

\*For additional information on our Pb-Free strategy and soldering details, please download the ON Semiconductor Soldering and Mounting Techniques Reference Manual, SOLDERRM/D.



# NCP4586

## PACKAGE DIMENSIONS

**SC-82AB**  
CASE 419C-02  
ISSUE E

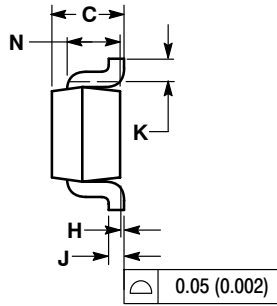
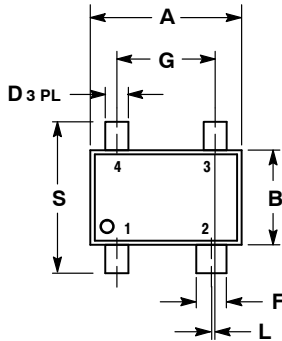

- NOTES:
1. DIMENSIONING AND TOLERANCING PER ANSI Y14.5M, 1982.
  2. CONTROLLING DIMENSION: MILLIMETER.
  3. 419C-01 OBSOLETE. NEW STANDARD IS 419C-02.
  4. DIMENSIONS A AND B DO NOT INCLUDE MOLD FLASH, PROTRUSIONS, OR GATE BURRS.

DIM	MILLIMETERS		INCHES	
	MIN	MAX	MIN	MAX
A	1.8	2.2	0.071	0.087
B	1.15	1.35	0.045	0.053
C	0.8	1.1	0.031	0.043
D	0.2	0.4	0.008	0.016
F	0.3	0.5	0.012	0.020
G	1.1	1.5	0.043	0.059
H	0.0	0.1	0.000	0.004
J	0.10	0.26	0.004	0.010
K	0.1	---	0.004	---
L	0.05 BSC		0.002 BSC	
N	0.2 REF		0.008 REF	
S	1.8	2.4	0.07	0.09

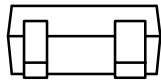

### SOLDERING FOOTPRINT\*

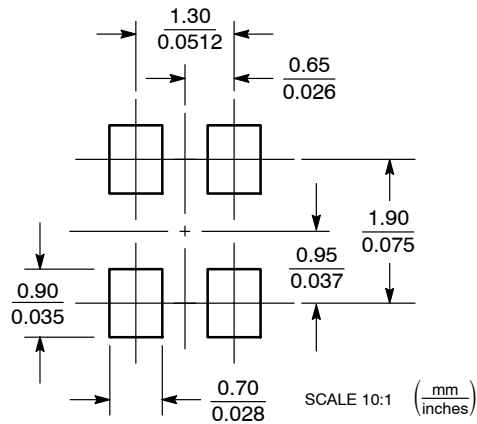

\*For additional information on our Pb-Free strategy and soldering details, please download the ON Semiconductor Soldering and Mounting Techniques Reference Manual, SOLDERRM/D.

# NCP4586

## PACKAGE DIMENSIONS

### SOT-23 5-LEAD CASE 1212-01 ISSUE A

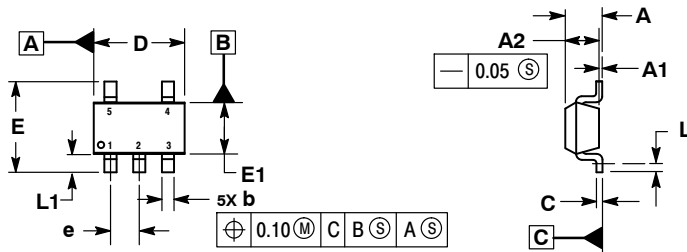

NOTES:

1. DIMENSIONING AND TOLERANCING PER ASME Y14.5M, 1994.
2. CONTROLLING DIMENSIONS: MILLIMETERS.
3. DATUM C IS THE SEATING PLANE.

DIM	MILLIMETERS	
	MIN	MAX
A	---	1.45
A1	0.00	0.10
A2	1.00	1.30
b	0.30	0.50
c	0.10	0.25
D	2.70	3.10
E	2.50	3.10
E1	1.50	1.80
e	0.95 BSC	
L	0.20	---
L1	0.45	0.75

### RECOMMENDED SOLDERING FOOTPRINT\*

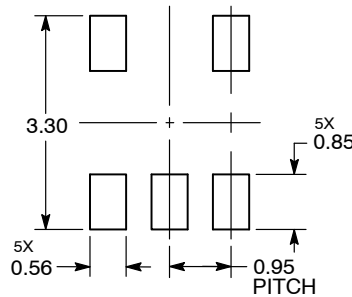

DIMENSIONS: MILLIMETERS

\*For additional information on our Pb-Free strategy and soldering details, please download the ON Semiconductor Soldering and Mounting Techniques Reference Manual, SOLDERRM/D.

ON Semiconductor and are registered trademarks of Semiconductor Components Industries, LLC (SCILLC). SCILLC reserves the right to make changes without further notice to any products herein. SCILLC makes no warranty, representation or guarantee regarding the suitability of its products for any particular purpose, nor does SCILLC assume any liability arising out of the application or use of any product or circuit, and specifically disclaims any and all liability, including without limitation special, consequential or incidental damages. "Typical" parameters which may be provided in SCILLC data sheets and/or specifications can and do vary in different applications and actual performance may vary over time. All operating parameters, including "Typicals" must be validated for each customer application by customer's technical experts. SCILLC does not convey any license under its patent rights nor the rights of others. SCILLC products are not designed, intended, or authorized for use as components in systems intended for surgical implant into the body, or other applications intended to support or sustain life, or for any other application in which the failure of the SCILLC product could create a situation where personal injury or death may occur. Should Buyer purchase or use SCILLC products for any such unintended or unauthorized application, Buyer shall indemnify and hold SCILLC and its officers, employees, subsidiaries, affiliates, and distributors harmless against all claims, costs, damages, and expenses, and reasonable attorney fees arising out of, directly or indirectly, any claim of personal injury or death associated with such unintended or unauthorized use, even if such claim alleges that SCILLC was negligent regarding the design or manufacture of the part. SCILLC is an Equal Opportunity/Affirmative Action Employer. This literature is subject to all applicable copyright laws and is not for resale in any manner.

### PUBLICATION ORDERING INFORMATION

**LITERATURE FULFILLMENT:**  
Literature Distribution Center for ON Semiconductor  
P.O. Box 5163, Denver, Colorado 80217 USA  
**Phone:** 303-675-2175 or 800-344-3860 Toll Free USA/Canada  
**Fax:** 303-675-2176 or 800-344-3867 Toll Free USA/Canada  
**Email:** orderlit@onsemi.com

**N. American Technical Support:** 800-282-9855 Toll Free  
USA/Canada  
**Europe, Middle East and Africa Technical Support:**  
Phone: 421 33 790 2910  
**Japan Customer Focus Center**  
Phone: 81-3-5817-1050

**ON Semiconductor Website:** [www.onsemi.com](http://www.onsemi.com)  
**Order Literature:** <http://www.onsemi.com/orderlit>

For additional information, please contact your local Sales Representative

# Mouser Electronics

Authorized Distributor

Click to View Pricing, Inventory, Delivery & Lifecycle Information:

## ON Semiconductor:

[NCP4586DMU33TCG](#) [NCP4586DSN50T1G](#) [NCP4586DSN18T1G](#) [NCP4586DSN12T1G](#) [NCP4586DSN28T1G](#)  
[NCP4586DSN33T1G](#) [NCP4586DMU12TCG](#) [NCP4586DMU18TCG](#) [NCP4586DMU28TCG](#) [NCP4586DMU30TCG](#)  
[NCP4586DMU50TCG](#) [NCP4586DSQ12T1G](#) [NCP4586DSQ18T1G](#) [NCP4586DSQ28T1G](#) [NCP4586DSQ30T1G](#)  
[NCP4586DSQ33T1G](#) [NCP4586DSQ50T1G](#) [NCP4586DMU14TCG](#) [NCP4586DMU15TCG](#) [NCP4586DMU25TCG](#)  
[NCP4586DSN30T1G](#)