

MGSF2N02EL, MVSF2N02EL

Power MOSFET

2.8 Amps, 20 Volts, N-Channel SOT-23

These miniature surface mount MOSFETs low $R_{DS(on)}$ assure minimal power loss and conserve energy, making these devices ideal for use in space sensitive power management circuitry.

Features

- Low $R_{DS(on)}$ Provides Higher Efficiency and Extends Battery Life
- Miniature SOT-23 Surface Mount Package Saves Board Space
- I_{DSS} Specified at Elevated Temperature
- AEC Q101 Qualified and PPAP Capable – MVSF2N02EL
- These Devices are Pb-Free and are RoHS Compliant

Applications

- DC-DC Converters
- Power Management in Portable and Battery Powered Products, ie: Computers, Printers, PCMCIA Cards, Cellular and Cordless Telephones

MAXIMUM RATINGS ($T_J = 25^\circ\text{C}$ unless otherwise noted)

Rating	Symbol	Value	Unit
Drain-to-Source Voltage	V_{DSS}	20	Vdc
Gate-to-Source Voltage – Continuous	V_{GS}	± 8.0	Vdc
Drain Current			A
– Continuous @ $T_A = 25^\circ\text{C}$	I_D	2.8	
– Single Pulse ($t_p = 10 \mu\text{s}$)	I_{DM}	5.0	
Total Power Dissipation @ $T_A = 25^\circ\text{C}$	P_D	1.25	W
Operating and Storage Temperature Range	T_J, T_{stg}	- 55 to 150	$^\circ\text{C}$
Thermal Resistance			$^\circ\text{C}/\text{W}$
Junction-to-Ambient (Note 1)	$R_{\theta JA}$	100	
Thermal Resistance			
Junction-to-Ambient (Note 2)		300	
Maximum Lead Temperature for Soldering Purposes, 1/8" from case for 10 seconds	T_L	260	$^\circ\text{C}$

Stresses exceeding those listed in the Maximum Ratings table may damage the device. If any of these limits are exceeded, device functionality should not be assumed, damage may occur and reliability may be affected.

1. 1" Pad, $t < 10$ sec.
2. Min pad, steady state.



ON Semiconductor®

<http://onsemi.com>

2.8 A, 20 V
 $R_{DS(on)} = 85 \text{ m}\Omega$ (max)

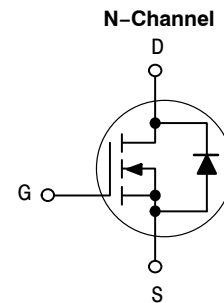

MARKING DIAGRAM

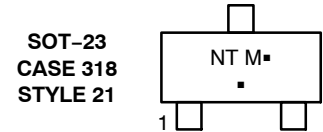
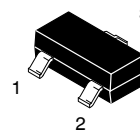

xxx = Specific Device Code
M = Date Code
■ = Pb-Free Package

PIN ASSIGNMENT

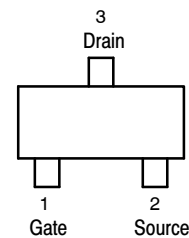

ORDERING INFORMATION

See detailed ordering and shipping information in the package dimensions section on page 2 of this data sheet.

MGSF2N02EL, MVSF2N02EL

ELECTRICAL CHARACTERISTICS (T_A = 25°C unless otherwise noted)

Characteristic	Symbol	Min	Typ	Max	Unit
----------------	--------	-----	-----	-----	------

OFF CHARACTERISTICS

Drain-to-Source Breakdown Voltage (Note 3) (V _{GS} = 0 Vdc, I _D = 10 μAdc) Temperature Coefficient (Positive)	V _{(BR)DSS}	20 -	- 22	- -	Vdc mV/°C
Zero Gate Voltage Drain Current (V _{DS} = 20 Vdc, V _{GS} = 0 Vdc) (V _{DS} = 20 Vdc, V _{GS} = 0 Vdc, T _J = 125°C)	I _{DSS}	- -	- -	1.0 10	μAdc
Gate-Source Leakage Current (V _{GS} = ± 8.0 Vdc, V _{DS} = 0 Vdc)	I _{GSS}	-	-	± 100	nA

ON CHARACTERISTICS (Note 3)

Gate-Source Threshold Voltage (V _{DS} = V _{GS} , I _D = 250 μAdc) Threshold Temperature Coefficient (Negative)	V _{GS(th)}	0.5 -	- -2.3	1.0 -	Vdc mV/°C
Static Drain-to-Source On-Resistance (V _{GS} = 4.5 Vdc, I _D = 3.6 A) (V _{GS} = 2.5 Vdc, I _D = 3.1 A)	R _{DS(on)}	- -	78 105	85 115	mΩ

DYNAMIC CHARACTERISTICS

Input Capacitance	(V _{DS} = 5.0 Vdc, V _{GS} = 0 V, f = 1.0 MHz)	C _{ISS}	-	150	-	pF
Output Capacitance		C _{OSS}	-	130	-	
Transfer Capacitance		C _{RSS}	-	45	-	

SWITCHING CHARACTERISTICS (Note 4)

Turn-On Delay Time	(V _{DD} = 16 Vdc, I _D = 2.8 Adc, V _{GS} = 4.5 V, R _G = 2.3 Ω)	t _{d(on)}	-	6.0	-	ns
Rise Time		t _r	-	95	-	
Turn-Off Delay Time		t _{d(off)}	-	28	-	
Fall Time		t _f	-	125	-	
Gate Charge	(V _{DS} = 16 Vdc, I _D = 1.75 Adc, V _{GS} = 4.0 Vdc) (Note 3)	Q _T	-	3.5	-	nC
		Q _{GS}	-	0.6	-	
		Q _{GD}	-	1.5	-	

SOURCE-DRAIN DIODE CHARACTERISTICS

Forward Voltage	(I _S = 1.0 Adc, V _{GS} = 0 Vdc) (Note 3)	V _{SD}	- -	0.76 -	1.2 -	V
Reverse Recovery Time	(I _S = 1.0 Adc, V _{GS} = 0 Vdc, di _S /dt = 100 A/μs) (Note 3)	t _{rr}	-	104	-	ns
		t _a	-	42	-	
		t _b	-	62	-	
Reverse Recovery Stored Charge		Q _{RR}	-	0.20	-	μC

Product parametric performance is indicated in the Electrical Characteristics for the listed test conditions, unless otherwise noted. Product performance may not be indicated by the Electrical Characteristics if operated under different conditions.

3. Pulse Test: Pulse Width ≤ 300 μs, Duty Cycle ≤ 2%.

4. Switching characteristics are independent of operating junction temperature.

ORDERING INFORMATION

Device	Package	Shipping†
MGSF2N02ELT1G	SOT-23 (Pb-Free)	3,000 / Tape & Reel
MVSF2N02ELT1G*		

†For information on tape and reel specifications, including part orientation and tape sizes, please refer to our Tape and Reel Packaging Specifications Brochure, BRD8011/D.

*MVSF Prefix for Automotive and Other Applications Requiring Unique Site and Control Change Requirements; AEC-Q101 Qualified and PPAP Capable.

MGSF2N02EL, MVSF2N02EL

TYPICAL CHARACTERISTICS

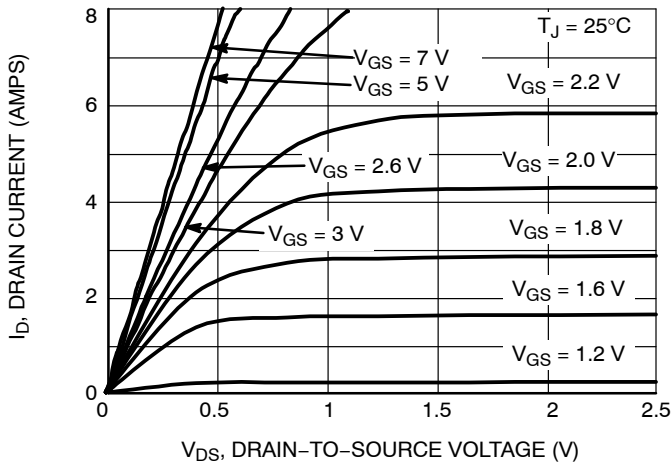

Figure 1. On-Region Characteristics

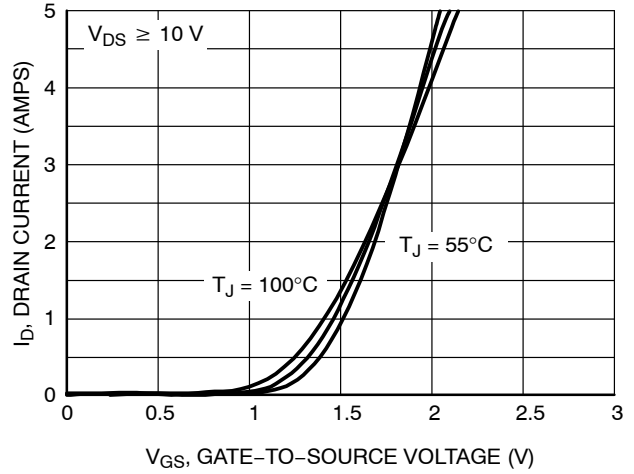

Figure 2. Transfer Characteristics

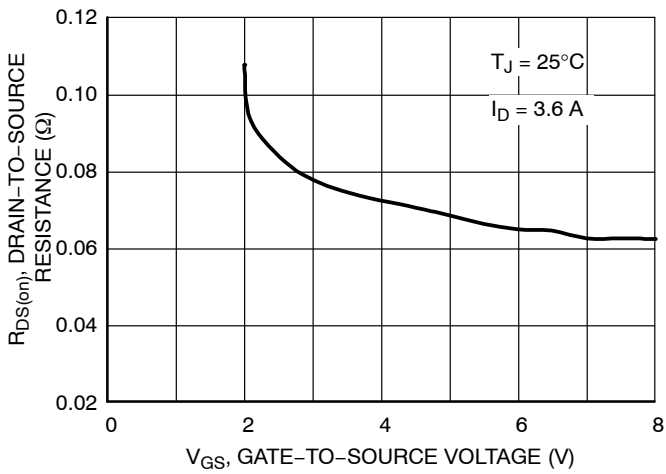

Figure 3. On-Resistance vs. Gate-to-Source Voltage

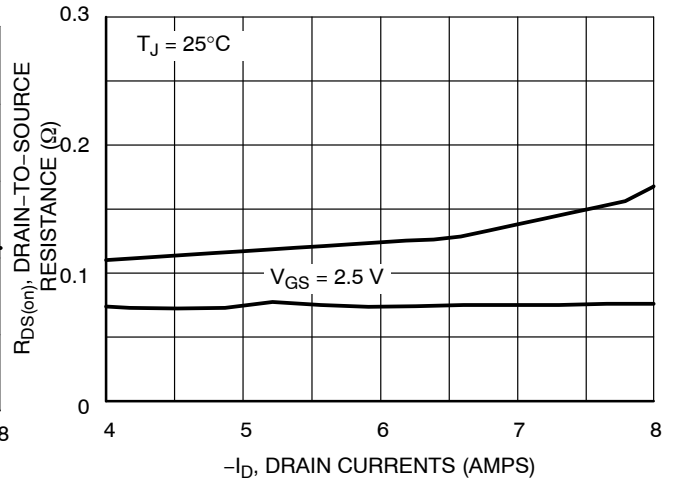

Figure 4. On-Resistance vs. Gate Voltage

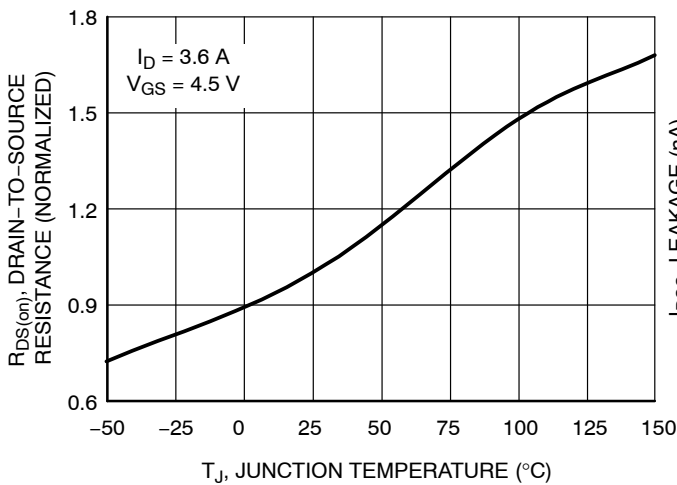

Figure 5. On-Resistance Variation with Temperature

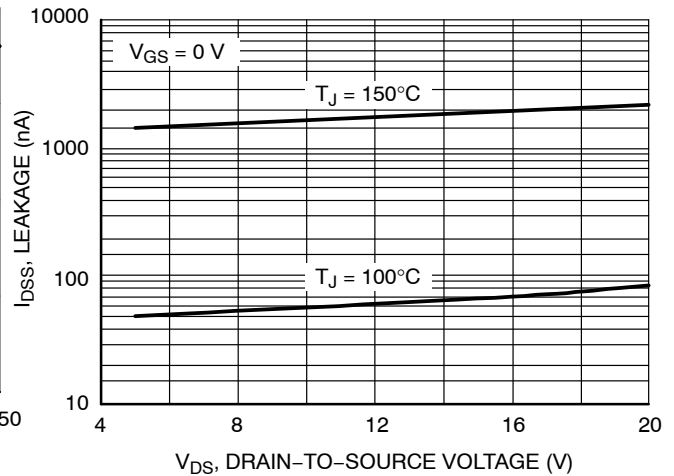

Figure 6. Drain-to-Source Leakage Current vs. Voltage

MGSF2N02EL, MVSF2N02EL

TYPICAL CHARACTERISTICS

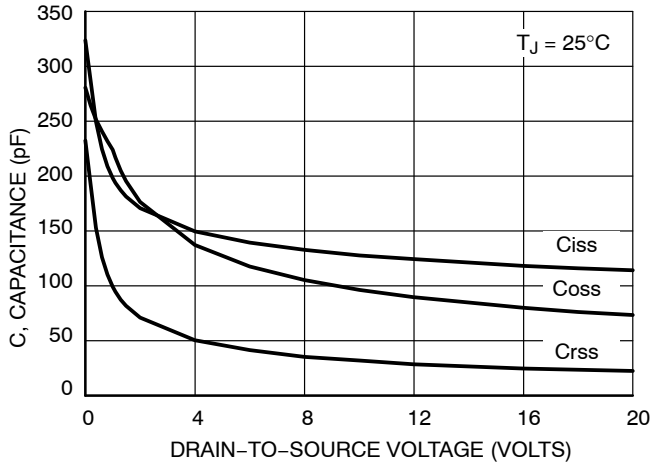

Figure 7. Capacitance Variation

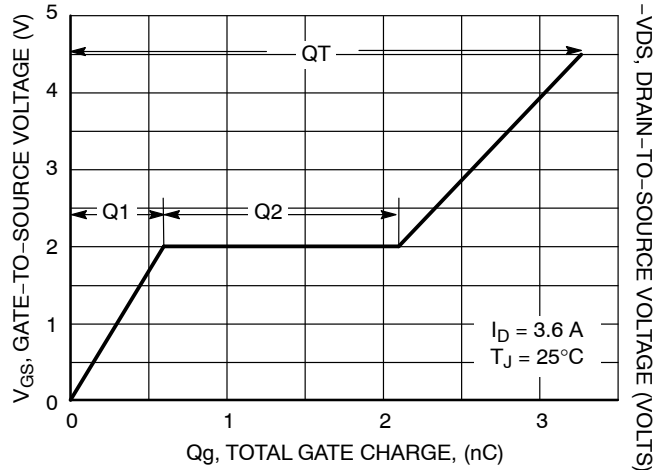

Figure 8. Gate-to-Source Voltage vs. Total Charge

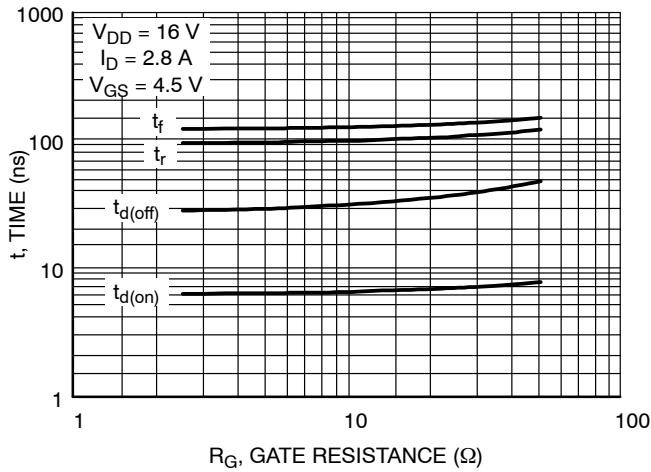

Figure 9. Resistive Switching Time Variation vs. Gate Resistance

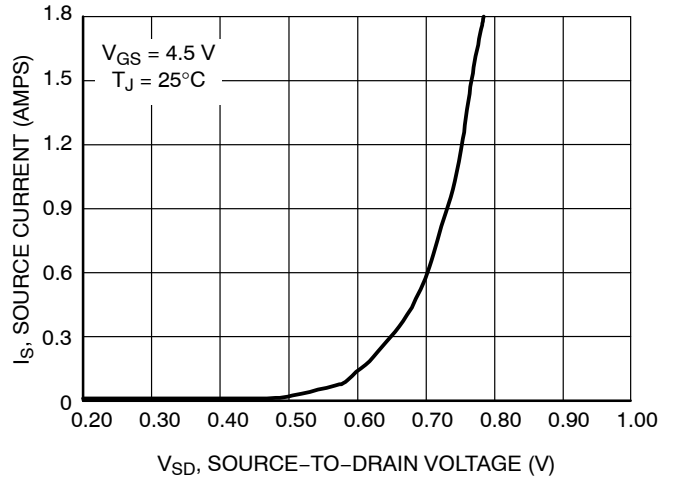
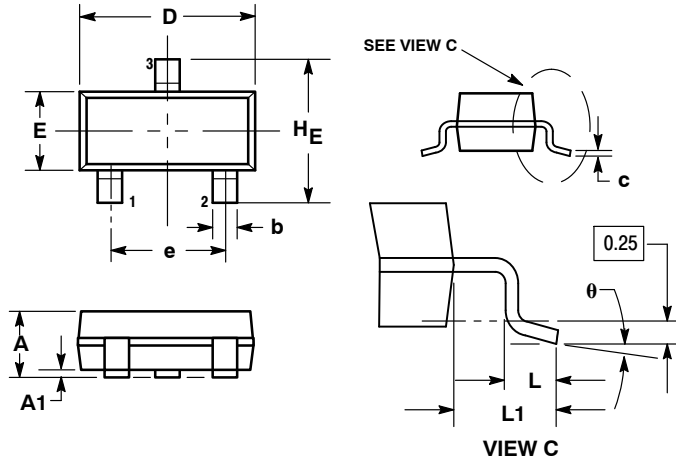

Figure 10. Diode Forward Voltage vs. Current

MGSF2N02EL, MVSF2N02EL

PACKAGE DIMENSIONS

SOT-23 (TO-236)
CASE 318-08
ISSUE AP



- NOTES:
1. DIMENSIONING AND TOLERANCING PER ANSI Y14.5M, 1982.
 2. CONTROLLING DIMENSION: INCH.
 3. MAXIMUM LEAD THICKNESS INCLUDES LEAD FINISH THICKNESS. MINIMUM LEAD THICKNESS IS THE MINIMUM THICKNESS OF BASE MATERIAL.
 4. DIMENSIONS D AND E DO NOT INCLUDE MOLD FLASH, PROTRUSIONS, OR GATE BURRS.

DIM	MILLIMETERS			INCHES		
	MIN	NOM	MAX	MIN	NOM	MAX
A	0.89	1.00	1.11	0.035	0.040	0.044
A1	0.01	0.06	0.10	0.001	0.002	0.004
b	0.37	0.44	0.50	0.015	0.018	0.020
c	0.09	0.13	0.18	0.003	0.005	0.007
D	2.80	2.90	3.04	0.110	0.114	0.120
E	1.20	1.30	1.40	0.047	0.051	0.055
e	1.78	1.90	2.04	0.070	0.075	0.081
L	0.10	0.20	0.30	0.004	0.008	0.012
L1	0.35	0.54	0.69	0.014	0.021	0.029
HE	2.10	2.40	2.64	0.083	0.094	0.104
θ	0°	---	10°	0°	---	10°

STYLE 21:
PIN 1. GATE
2. SOURCE
3. DRAIN

SOLDERING FOOTPRINT*

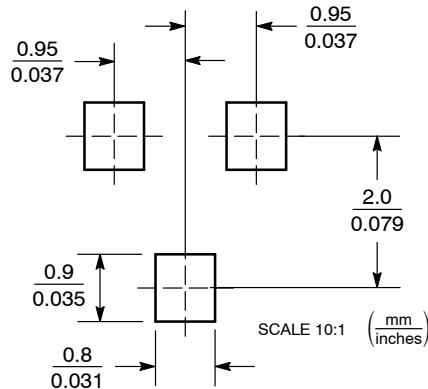

*For additional information on our Pb-Free strategy and soldering details, please download the ON Semiconductor Soldering and Mounting Techniques Reference Manual, SOLDERRM/D.

ON Semiconductor and  are registered trademarks of Semiconductor Components Industries, LLC (SCILLC). SCILLC owns the rights to a number of patents, trademarks, copyrights, trade secrets, and other intellectual property. A listing of SCILLC's product/patent coverage may be accessed at www.onsemi.com/site/pdf/Patent-Marking.pdf. SCILLC reserves the right to make changes without further notice to any products herein. SCILLC makes no warranty, representation or guarantee regarding the suitability of its products for any particular purpose, nor does SCILLC assume any liability arising out of the application or use of any product or circuit, and specifically disclaims any and all liability, including without limitation special, consequential or incidental damages. "Typical" parameters which may be provided in SCILLC data sheets and/or specifications can and do vary in different applications and actual performance may vary over time. All operating parameters, including "Typicals" must be validated for each customer application by customer's technical experts. SCILLC does not convey any license under its patent rights nor the rights of others. SCILLC products are not designed, intended, or authorized for use as components in systems intended for surgical implant into the body, or other applications intended to support or sustain life, or for any other application in which the failure of the SCILLC product could create a situation where personal injury or death may occur. Should Buyer purchase or use SCILLC products for any such unintended or unauthorized application, Buyer shall indemnify and hold SCILLC and its officers, employees, subsidiaries, affiliates, and distributors harmless against all claims, costs, damages, and expenses, and reasonable attorney fees arising out of, directly or indirectly, any claim of personal injury or death associated with such unintended or unauthorized use, even if such claim alleges that SCILLC was negligent regarding the design or manufacture of the part. SCILLC is an Equal Opportunity/Affirmative Action Employer. This literature is subject to all applicable copyright laws and is not for resale in any manner.

PUBLICATION ORDERING INFORMATION

LITERATURE FULFILLMENT:
Literature Distribution Center for ON Semiconductor
P.O. Box 5163, Denver, Colorado 80217 USA
Phone: 303-675-2175 or 800-344-3860 Toll Free USA/Canada
Fax: 303-675-2176 or 800-344-3867 Toll Free USA/Canada
Email: orderlit@onsemi.com

N. American Technical Support: 800-282-9855 Toll Free
USA/Canada
Europe, Middle East and Africa Technical Support:
Phone: 421 33 790 2910
Japan Customer Focus Center
Phone: 81-3-5817-1050

ON Semiconductor Website: www.onsemi.com
Order Literature: <http://www.onsemi.com/orderlit>
For additional information, please contact your local Sales Representative

Mouser Electronics

Authorized Distributor

Click to View Pricing, Inventory, Delivery & Lifecycle Information:

[ON Semiconductor:](#)

[MVSF2N02ELT1G](#)