

# CAT34C02

## 2 kb I<sup>2</sup>C EEPROM for DDR2 DIMM Serial Presence Detect

### Description

The CAT34C02 is a 2 kb Serial CMOS EEPROM, internally organized as 16 pages of 16 bytes each, for a total of 256 bytes of 8 bits each.

It features a 16-byte page write buffer and supports both the Standard (100 kHz) as well as Fast (400 kHz) I<sup>2</sup>C protocol.

Write operations can be inhibited by taking the WP pin High (this protects the entire memory) or by setting an internal Write Protect flag via Software command (this protects the lower half of the memory).

**In addition to Permanent Software Write Protection, the CAT34C02 also features JEDEC compatible Reversible Software Write Protection for DDR2 Serial Presence Detect (SPD) applications operating over the 1.7 V to 3.6 V supply voltage range.**

**The CAT34C02 is fully backwards compatible with earlier DDR1 SPD applications operating over the 1.7 V to 5.5 V supply voltage range.**

### Features

- Supports Standard and Fast I<sup>2</sup>C Protocol
- 1.7 V to 5.5 V Supply Voltage Range
- 16-Byte Page Write Buffer
- Hardware Write Protection for Entire Memory
- Software Write Protection for Lower 128 Bytes
- Schmitt Triggers and Noise Suppression Filters on I<sup>2</sup>C Bus Inputs (SCL and SDA)
- Low power CMOS Technology
- 1,000,000 Program/Erase Cycles
- 100 Year Data Retention
- Industrial Temperature Range
- This Device is Pb-Free, Halogen Free/BFR Free and RoHS Compliant\*

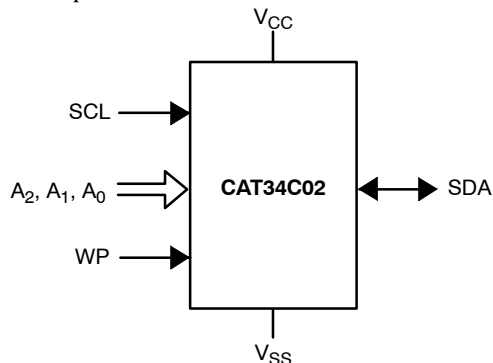

Figure 1. Functional Symbol

\*For additional information on our Pb-Free strategy and soldering details, please download the ON Semiconductor Soldering and Mounting Techniques Reference Manual, SOLDERRM/D.



ON Semiconductor®

<http://onsemi.com>



TSSOP-8  
Y SUFFIX  
CASE 948AL



TDFN-8  
VP2 SUFFIX  
CASE 511AK



UDFN-8  
HU3 SUFFIX  
CASE 517AX



UDFN-8 EP  
HU4 SUFFIX  
CASE 517AZ

### PIN CONFIGURATION

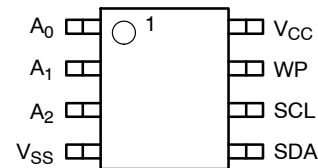

TSSOP (Y), TDFN (VP2),  
UDFN (HU3), UDFN (HU4)

For the location of Pin 1, please consult the corresponding package drawing.

### PIN FUNCTION

Pin Name	Function
A <sub>0</sub> , A <sub>1</sub> , A <sub>2</sub>	Device Address Input
SDA	Serial Data Input/Output
SCL	Serial Clock Input
WP	Write Protect Input
V <sub>CC</sub>	Power Supply
V <sub>SS</sub>	Ground

### ORDERING INFORMATION

See detailed ordering and shipping information in the package dimensions section on page 14 of this data sheet.

# CAT34C02

**Table 1. ABSOLUTE MAXIMUM RATINGS**

Parameter	Rating	Unit
Operating Temperature	-45 to +130	°C
Storage Temperature	-65 to +150	°C
Voltage on Any Pin with Respect to Ground (Note 1)	-0.5 to +6.5	V
Voltage on Pin A <sub>0</sub> with Respect to Ground	-0.5 to +10.5	V

Stresses exceeding Maximum Ratings may damage the device. Maximum Ratings are stress ratings only. Functional operation above the Recommended Operating Conditions is not implied. Extended exposure to stresses above the Recommended Operating Conditions may affect device reliability.

- The DC input voltage on any pin should not be lower than -0.5 V or higher than  $V_{CC} + 0.5$  V. During transitions, the voltage on any pin may undershoot to no less than -1.5 V or overshoot to no more than  $V_{CC} + 1.5$  V, for periods of less than 20 ns.

**Table 2. RELIABILITY CHARACTERISTICS (Note 2)**

Symbol	Parameter	Min	Units
N <sub>END</sub> (Note 3)	Endurance	1,000,000	Program/ Erase Cycles
T <sub>DR</sub>	Data Retention	100	Years

- These parameters are tested initially and after a design or process change that affects the parameter according to appropriate AEC-Q100 and JEDEC test methods.
- Page Mode,  $V_{CC} = 5$  V, 25°C

**Table 3. D.C. OPERATING CHARACTERISTICS** ( $V_{CC} = 1.7$  V to 5.5 V,  $T_A = -40$ °C to +85°C, unless otherwise specified.)

Symbol	Parameter	Test Conditions	Min	Max	Units
I <sub>CC</sub>	Supply Current	$V_{CC} < 3.6$ V, $f_{SCL} = 100$ kHz		1	mA
		$V_{CC} > 3.6$ V, $f_{SCL} = 400$ kHz		2	
I <sub>SB</sub>	Standby Current	All I/O Pins at GND or $V_{CC}$	$T_A = -40$ °C to +85°C $V_{CC} \leq 3.3$ V	1	μA
			$T_A = -40$ °C to +85°C $V_{CC} > 3.3$ V	3	
I <sub>L</sub>	I/O Pin Leakage	Pin at GND or $V_{CC}$		2	μA
V <sub>IL</sub>	Input Low Voltage		-0.5	$0.3 \times V_{CC}$	V
V <sub>IH</sub>	Input High Voltage		$0.7 \times V_{CC}$	$V_{CC} + 0.5$	
V <sub>OL</sub>	Output Low Voltage	$V_{CC} > 2.5$ V, I <sub>OL</sub> = 3 mA		0.4	
		$V_{CC} < 2.5$ V, I <sub>OL</sub> = 1 mA		0.2	

**Table 4. PIN IMPEDANCE CHARACTERISTICS** ( $V_{CC} = 1.7$  V to 5.5 V,  $T_A = -40$ °C to +85°C, unless otherwise specified.)

Symbol	Parameter	Conditions	Max	Units
C <sub>IN</sub> (Note 4)	SDA I/O Pin Capacitance	$V_{IN} = 0$ V, $f = 1.0$ MHz, $V_{CC} = 5.0$ V	8	pF
	Other Input Pins		6	
I <sub>WP</sub> (Note 5)	WP Input Current	$V_{IN} < V_{IH}$ , $V_{CC} = 5.5$ V	130	μA
		$V_{IN} < V_{IH}$ , $V_{CC} = 3.6$ V	120	
		$V_{IN} < V_{IH}$ , $V_{CC} = 1.7$ V	80	
		$V_{IN} > V_{IH}$	2	
I <sub>A</sub> (Note 5)	Address Input Current (A0, A1, A2) Product Rev H	$V_{IN} < V_{IH}$ , $V_{CC} = 5.5$ V	50	μA
		$V_{IN} < V_{IH}$ , $V_{CC} = 3.6$ V	35	
		$V_{IN} < V_{IH}$ , $V_{CC} = 1.7$ V	25	
		$V_{IN} > V_{IH}$	2	

- These parameters are tested initially and after a design or process change that affects the parameter according to appropriate AEC-Q100 and JEDEC test methods.
- When not driven, the WP, A0, A1 and A2 pins are pulled down to GND internally. For improved noise immunity, the internal pull-down is relatively strong; therefore the external driver must be able to supply the pull-down current when attempting to drive the input HIGH. To conserve power, as the input level exceeds the trip point of the CMOS input buffer ( $\sim 0.5 \times V_{CC}$ ), the strong pull-down reverts to a weak current source.

# CAT34C02

**Table 5. A.C. CHARACTERISTICS** ( $V_{CC} = 1.7\text{ V to }5.5\text{ V}$ ,  $T_A = -40^\circ\text{C to }+85^\circ\text{C}$ ) (Note 6)

Symbol	Parameter	Standard		Fast		Units
		Min	Max	Min	Max	
$F_{SCL}$	Clock Frequency		100		400	kHz
$t_{HD:STA}$	START Condition Hold Time	4		0.6		$\mu\text{s}$
$t_{LOW}$	Low Period of SCL Clock	4.7		1.3		$\mu\text{s}$
$t_{HIGH}$	High Period of SCL Clock	4		0.6		$\mu\text{s}$
$t_{SU:STA}$	START Condition Setup Time	4.7		0.6		$\mu\text{s}$
$t_{HD:DAT}$	Data Hold Time	0		0		$\mu\text{s}$
$t_{SU:DAT}$	Data Setup Time	250		100		ns
$t_R$ (Note 7)	SDA and SCL Rise Time		1000		300	ns
$t_F$ (Note 7)	SDA and SCL Fall Time		300		300	ns
$t_{SU:STO}$	STOP Condition Setup Time	4		0.6		$\mu\text{s}$
$t_{BUF}$	Bus Free Time Between STOP and START	4.7		1.3		$\mu\text{s}$
$t_{AA}$	SCL Low to SDA Data Out		3.5		0.9	$\mu\text{s}$
$t_{DH}$	Data Out Hold Time	100		100		ns
$T_i$ (Note 7)	Noise Pulse Filtered at SCL and SDA Inputs		100		100	ns
$t_{SU:WP}$	WP Setup Time	0		0		$\mu\text{s}$
$t_{HD:WP}$	WP Hold Time	2.5		2.5		$\mu\text{s}$
$t_{WR}$	Write Cycle Time		5		5	ms
$t_{PU}$ (Notes 7 & 8)	Power-up to Ready Mode		1		1	ms

6. Test conditions according to "A.C. Test Conditions" table.

7. Tested initially and after a design or process change that affects this parameter.

8.  $t_{PU}$  is the delay between the time  $V_{CC}$  is stable and the device is ready to accept commands.

**Table 6. THERMAL CHARACTERISTICS** (Air velocity = 0 m/s, 4 layers PCB) (Notes 9 and 10)

Part Number	Package	$\theta_{JA}$	$\theta_{JC}$	Units
CAT34C02Y	TSSOP	64	37	$^\circ\text{C/W}$
CAT34C02VP2	TDFN	92	15	$^\circ\text{C/W}$
CAT34C02HU3	UDFN	101	18	$^\circ\text{C/W}$
CAT34C02HU4	UDFN	101	18	$^\circ\text{C/W}$

9.  $T_J = T_A + P_D * \theta_{JA}$ , where:  $T_J$  is the Junction Temperature,  $T_A$  the Ambient Temperature,  $P_D$  the Power dissipation.

Example: CAT34C02VP2,  $V_{CC} = 3.0\text{ V}$ ,  $I_{CCmax} = 1\text{ mA}$ ,  $T_A = 85^\circ\text{C}$ :  $T_J = 85^\circ\text{C} + 3\text{ mW} * 92^\circ\text{C/W} = 85.276^\circ\text{C}$ .

10.  $T_J = T_C + P_D * \theta_{JC}$ , where:  $T_C$  is the Case Temperature, etc.

**Table 7. A.C. TEST CONDITIONS**

Input Levels	$0.2 V_{CC}$ to $0.8 V_{CC}$
Input Rise and Fall Times	$\leq 50\text{ ns}$
Input Reference Levels	$0.3 V_{CC}$ , $0.7 V_{CC}$
Output Reference Levels	$0.5 V_{CC}$
Output Load	Current Source: $I_{OL} = 3\text{ mA}$ ( $V_{CC} \geq 2.5\text{ V}$ ); $I_{OL} = 1\text{ mA}$ ( $V_{CC} < 2.5\text{ V}$ ); $C_L = 100\text{ pF}$

**Power-On Reset (POR)**

The CAT34C02 incorporates Power-On Reset (POR) circuitry which protects the internal logic against powering up in the wrong state.

The CAT34C02 will power up into Standby mode after  $V_{CC}$  exceeds the POR trigger level and will power down into Reset mode when  $V_{CC}$  drops below the POR trigger level. This bi-directional POR feature protects the device against ‘brown-out’ failure following a temporary loss of power.

**Pin Description**

**SCL:** The Serial Clock input pin accepts the Serial Clock generated by the Master.

**SDA:** The Serial Data I/O pin receives input data and transmits data stored in EEPROM. In transmit mode, this pin is open drain. Data is acquired on the positive edge, and is delivered on the negative edge of SCL.

**A<sub>0</sub>, A<sub>1</sub> and A<sub>2</sub>:** The Address pins accept the device address. These pins have on-chip pull-down resistors.

**WP:** The Write Protect input pin inhibits all write operations, when pulled HIGH. This pin has an on-chip pull-down resistor.

**Functional Description**

The CAT34C02 supports the Inter-Integrated Circuit (I<sup>2</sup>C) Bus data transmission protocol, which defines a device that sends data to the bus as a transmitter and a device receiving data as a receiver. Data flow is controlled by a Master device, which generates the serial clock and all START and STOP conditions. The CAT34C02 acts as a Slave device. Master and Slave alternate as either transmitter or receiver. Up to 8 devices may be connected to the bus as determined by the device address inputs A<sub>0</sub>, A<sub>1</sub>, and A<sub>2</sub>.

**I<sup>2</sup>C Bus Protocol**

The I<sup>2</sup>C bus consists of two ‘wires’, SCL and SDA. The two wires are connected to the  $V_{CC}$  supply via pull-up resistors. Master and Slave devices connect to the 2-wire bus via their respective SCL and SDA pins. The transmitting

device pulls down the SDA line to ‘transmit’ a ‘0’ and releases it to ‘transmit’ a ‘1’.

Data transfer may be initiated only when the bus is not busy (see A.C. Characteristics).

During data transfer, the SDA line must remain stable while the SCL line is HIGH. An SDA transition while SCL is HIGH will be interpreted as a START or STOP condition (Figure 2).

**Start**

The START condition precedes all commands. It consists of a HIGH to LOW transition on SDA while SCL is HIGH. The START acts as a ‘wake-up’ call to all receivers. Absent a START, a Slave will not respond to commands.

**Stop**

The STOP condition completes all commands. It consists of a LOW to HIGH transition on SDA while SCL is HIGH. The STOP starts the internal Write cycle (when following a Write command) or sends the Slave into standby mode (when following a Read command).

**Device Addressing**

The Master initiates data transfer by creating a START condition on the bus. The Master then broadcasts an 8-bit serial Slave address. The first 4 bits of the Slave address are set to 1010, for normal Read/Write operations (Figure 3). The next 3 bits, A<sub>2</sub>, A<sub>1</sub> and A<sub>0</sub>, select one of 8 possible Slave devices. The last bit,  $R/\overline{W}$ , specifies whether a Read (1) or Write (0) operation is to be performed.

**Acknowledge**

After processing the Slave address, the Slave responds with an acknowledge (ACK) by pulling down the SDA line during the 9<sup>th</sup> clock cycle (Figure 4). The Slave will also acknowledge the byte address and every data byte presented in Write mode. In Read mode the Slave shifts out a data byte, and then releases the SDA line during the 9<sup>th</sup> clock cycle. If the Master acknowledges the data, then the Slave continues transmitting. The Master terminates the session by not acknowledging the last data byte (NoACK) and by sending a STOP to the Slave. Bus timing is illustrated in Figure 5.

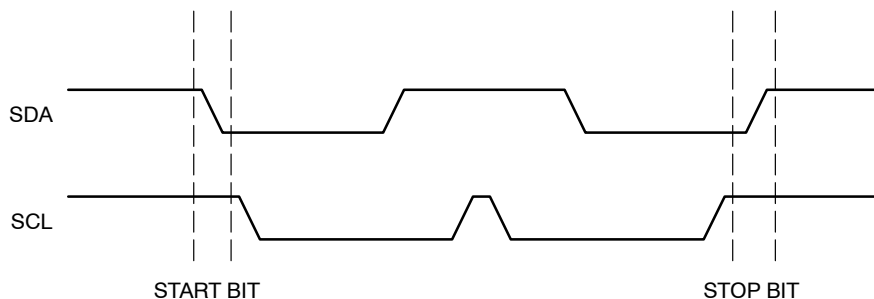
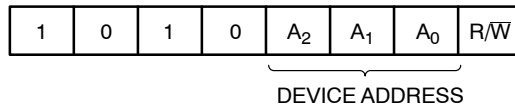
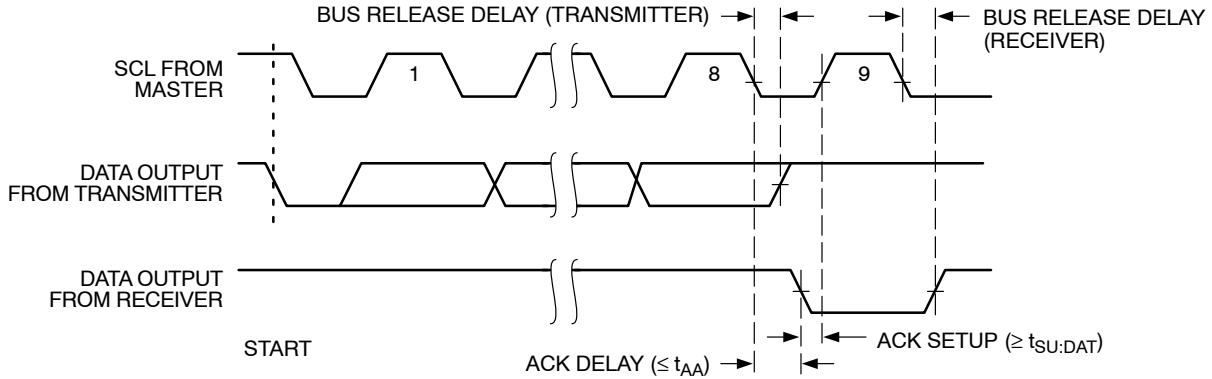

Figure 2. Start/Stop Timing

# CAT34C02



**Figure 3. Slave Address Bits**



**Figure 4. Acknowledge Timing**

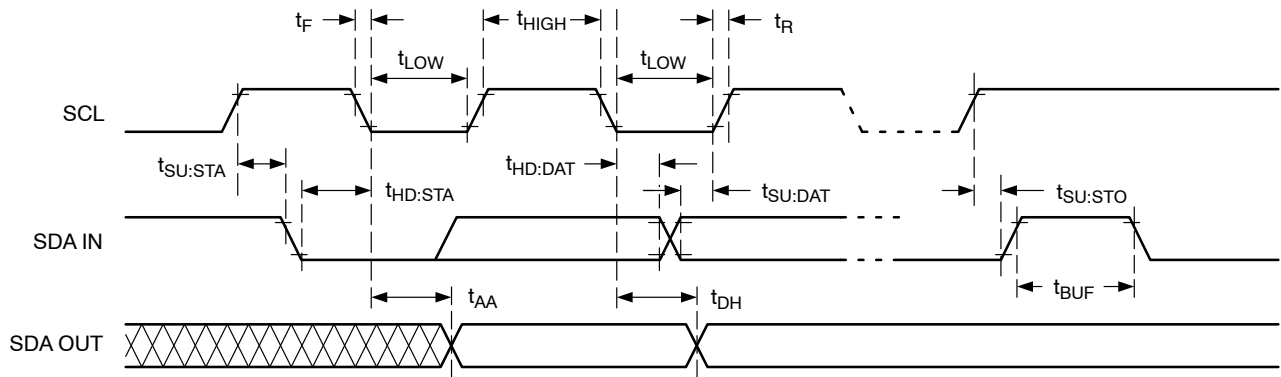

**Figure 5. Bus Timing**

## Write Operations

### Byte Write

In Byte Write mode the Master sends a START, followed by Slave address, byte address and data to be written (Figure 6). The Slave acknowledges all 3 bytes, and the Master then follows up with a STOP, which in turn starts the internal Write operation (Figure 7). During internal Write, the Slave will not acknowledge any Read or Write request from the Master.

### Page Write

The CAT34C02 contains 256 bytes of data, arranged in 16 pages of 16 bytes each. A page is selected by the 4 most significant bits of the address byte following the Slave address, while the 4 least significant bits point to the byte within the page. Up to 16 bytes can be written in one Write cycle (Figure 8).

The internal byte address counter is automatically incremented after each data byte is loaded. If the Master transmits more than 16 data bytes, then earlier bytes will be overwritten by later bytes in a ‘wrap-around’ fashion (within the selected page). The internal Write cycle starts immediately following the STOP.

### Acknowledge Polling

Acknowledge polling can be used to determine if the CAT34C02 is busy writing or is ready to accept commands. Polling is implemented by interrogating the device with a ‘Selective Read’ command (see READ OPERATIONS).

The CAT34C02 will not acknowledge the Slave address, as long as internal Write is in progress.

### Delivery State

The CAT34C02 is shipped ‘unprotected’, i.e. neither SWP flag is set. The entire 2 kb memory is erased, i.e. all bytes are FFh.

# CAT34C02

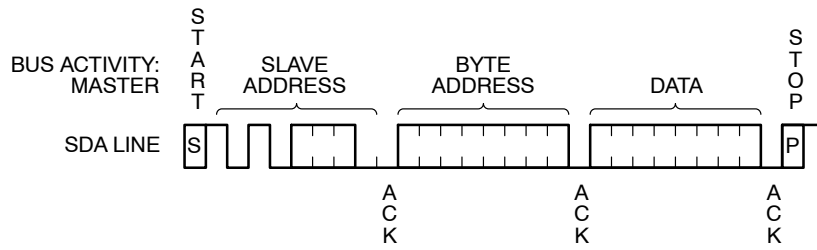

Figure 6. Byte Write Timing

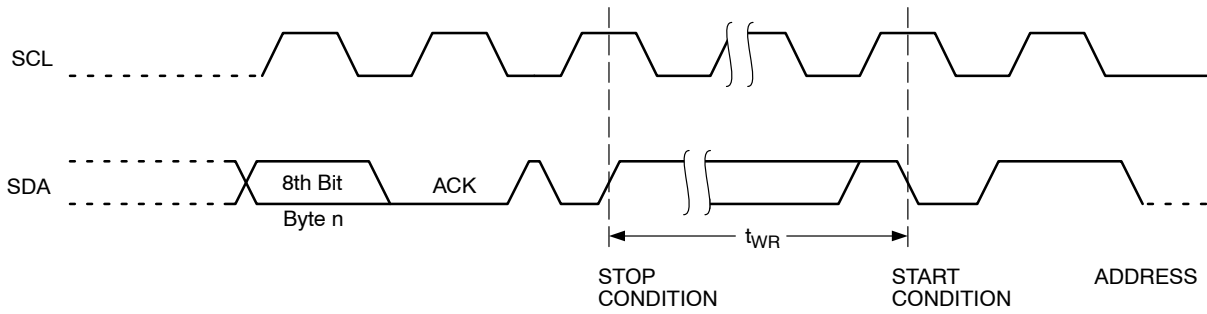
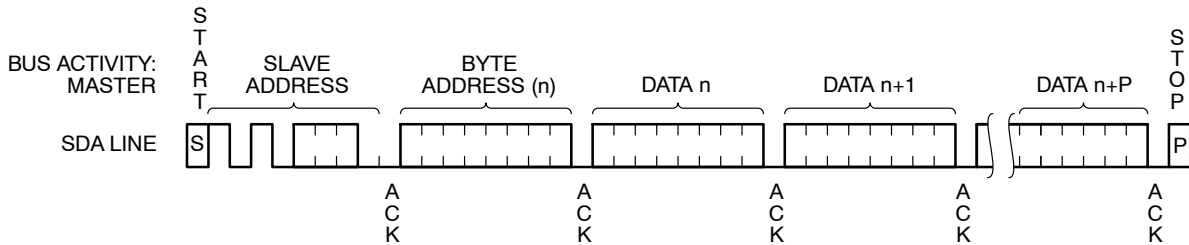

Figure 7. Write Cycle Timing



NOTE: IN THIS EXAMPLE  $n = \text{XXXX } 0000(\text{B}); X = 1 \text{ or } 0$

Figure 8. Page Write Timing

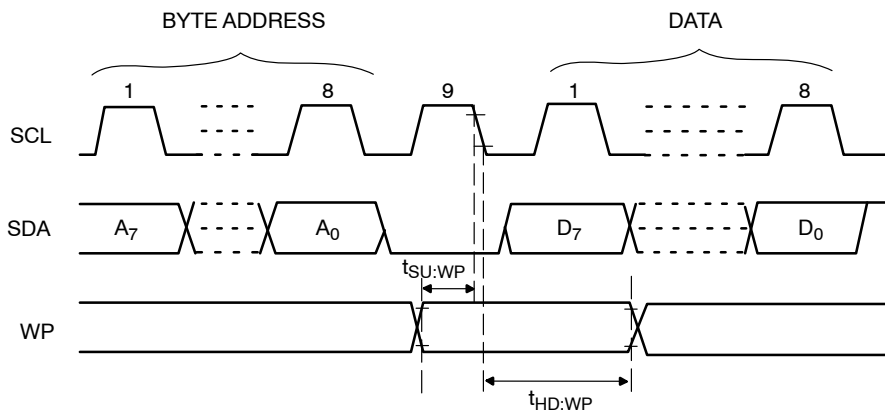

Figure 9. WP Timing

**Read Operations**

**Immediate Address Read**

In standby mode, the CAT34C02 internal address counter points to the data byte immediately following the last byte accessed by a previous operation. If that 'previous' byte was the last byte in memory, then the address counter will point to the 1<sup>st</sup> memory byte, etc.

When, following a START, the CAT34C02 is presented with a Slave address containing a '1' in the R/W bit position (Figure 10), it will acknowledge (ACK) in the 9<sup>th</sup> clock cycle, and will then transmit data being pointed at by the internal address counter. The Master can stop further transmission by issuing a NoACK, followed by a STOP condition.

**Selective Read**

The Read operation can also be started at an address different from the one stored in the internal address counter.

The address counter can be initialized by performing a 'dummy' Write operation (Figure 11). Here the START is followed by the Slave address (with the R/W bit set to '0') and the desired byte address. Instead of following up with data, the Master then issues a 2<sup>nd</sup> START, followed by the 'Immediate Address Read' sequence, as described earlier.

**Sequential Read**

If the Master acknowledges the 1<sup>st</sup> data byte transmitted by the CAT34C02, then the device will continue transmitting as long as each data byte is acknowledged by the Master (Figure 12). If the end of memory is reached during sequential Read, then the address counter will 'wrap-around' to the beginning of memory, etc. Sequential Read works with either 'Immediate Address Read' or 'Selective Read', the only difference being the starting byte address.

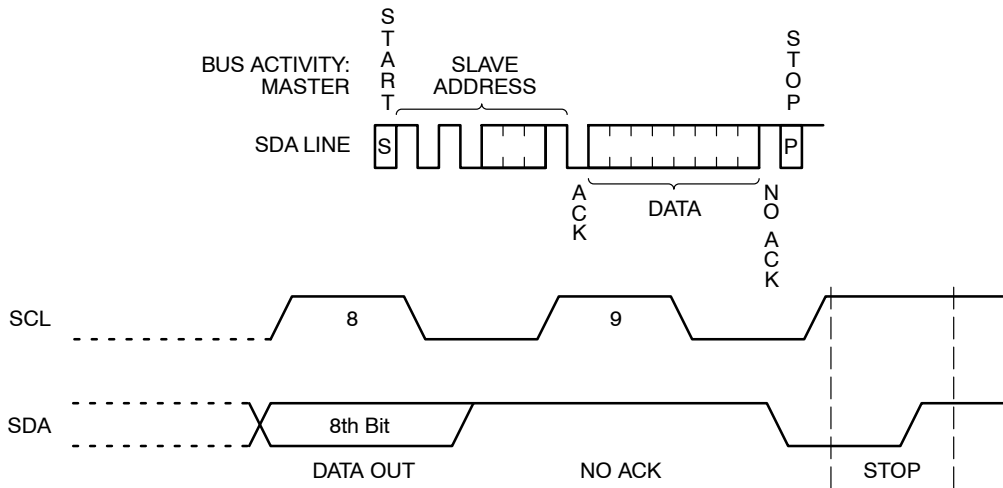

**Figure 10. Immediate Address Read Timing**

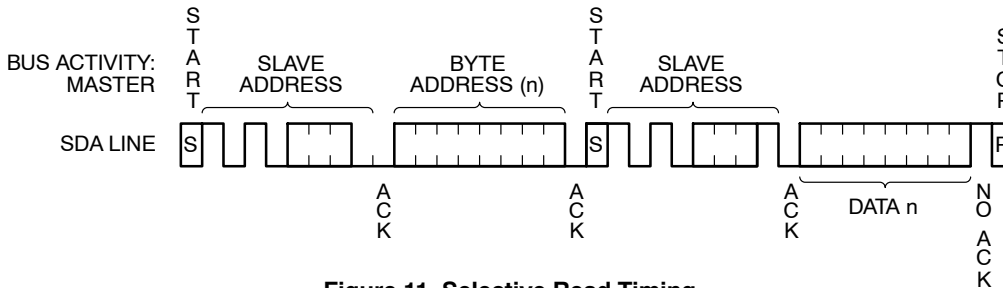

**Figure 11. Selective Read Timing**

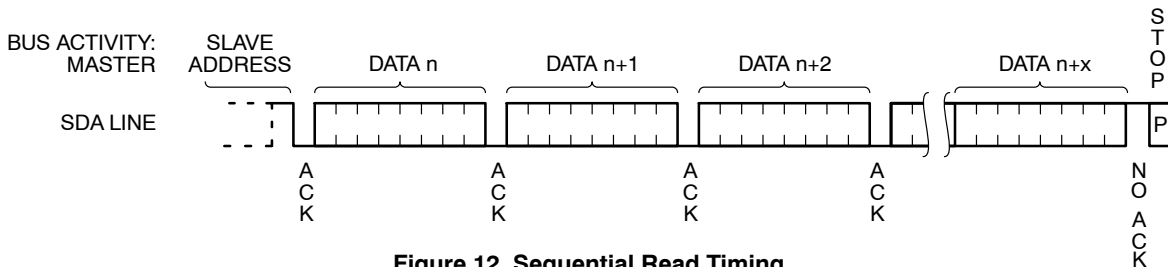

**Figure 12. Sequential Read Timing**

# CAT34C02

## Software Write Protection

The lower half of memory (first 128 bytes) can be protected against Write requests by setting one of two Software Write Protection (SWP) flags.

The Permanent Software Write Protection (PSWP) flag can be set or read while all address pins are at regular CMOS levels (GND or  $V_{CC}$ ), whereas the very high voltage  $V_{HV}$  must be present on address pin  $A_0$  to set, clear or read the Reversible Software Write Protection (RSWP) flag. The D.C. OPERATING CONDITIONS for RSWP operations are shown in Table 8.

The SWP commands are listed in Table 9. All commands are preceded by a START and terminated with a STOP, following the ACK or NoACK from the CAT34C02. All SWP related Slave addresses use the pre-ambule: 0110 (6h), instead of the regular 1010 (Ah) used for memory access. For PSWP commands, the three address pins can be at any logic level, whereas for RSWP commands the address pins must be at pre-assigned logic levels.  $V_{HV}$  is interpreted as logic '1'. The  $V_{HV}$  condition must be established on pin  $A_0$  before the START and maintained just beyond the STOP. Otherwise an RSWP request could be interpreted by the CAT34C02 as a PSWP request.

The SWP Slave addresses follow the standard I<sup>2</sup>C convention, i.e. to read the state of the SWP flag, the LSB of the Slave address must be '1', and to set or clear a flag, it must be '0'. For Write commands a dummy byte address and dummy data byte must be provided (Figure 14). In contrast to a regular memory Read, a SWP Read does not return Data. Instead the CAT34C02 will respond with NoACK if the flag

is set and with ACK if the flag is not set. Therefore, the Master can immediately follow up with a STOP, as there is no meaningful data following the ACK interval (Figure 15).

## Hardware Write Protection

With the WP pin held HIGH, the entire memory, as well as the SWP flags are protected against Write operations, see Memory Protection Map below. If the WP pin is left floating or is grounded, it has no impact on the operation of the CAT34C02.

The state of the WP pin is strobed on the last falling edge of SCL immediately preceding the first data byte (Figure 9). If the WP pin is HIGH during the strobe interval, the CAT34C02 will not acknowledge the data byte and the Write request will be rejected.

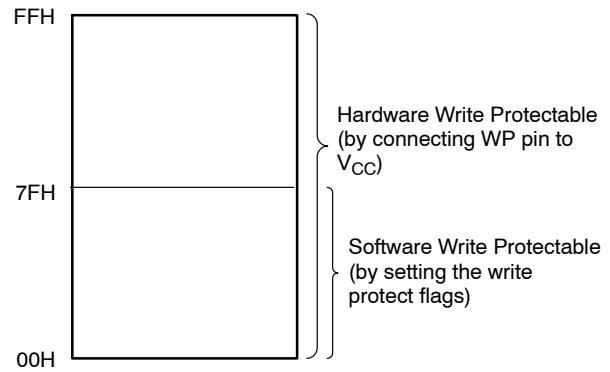

Figure 13. Memory Protection Map

Table 8. RSWP D.C. OPERATING CONDITIONS (Note 11)

Symbol	Parameter	Test Conditions	Min	Max	Units
$\Delta V_{HV}$	$A_0$ Overdrive ( $V_{HV} - V_{CC}$ )	$1.7\text{ V} < V_{CC} < 3.6\text{ V}$	4.8		V
$I_{HVD}$	$A_0$ High Voltage Detector Current			0.1	mA
$V_{HV}$	$A_0$ Very High Voltage		7	10	V
$I_{HV}$	$A_0$ Input Current @ $V_{HV}$			1	mA

11. To prevent damaging the CAT34C02 while applying  $V_{HV}$ , it is strongly recommended to limit the power delivered to pin  $A_0$ , by inserting a series resistor ( $> 1.5\text{ k}\Omega$ ) between the supply and the input pin. The resistance is only limited by the combination of  $V_{HV}$  and maximum  $I_{HVD}$ . While the resistor can be omitted if  $V_{HV}$  is clamped well below 10 V, it nevertheless provides simple protection against EOS events. As an example:  $V_{CC} = 1.7\text{ V}$ ,  $V_{HV} = 8\text{ V}$ ,  $1.5\text{ k}\Omega < R_S < 15\text{ k}\Omega$ .



# CAT34C02

**Table 9. SWP COMMANDS**

Action	Control Pin Levels (Note 12)				Flag State (Note 13)		Slave Address					ACK ?	Address Byte	ACK ?	Data Byte	ACK ?	Write Cycle
	WP	A <sub>2</sub>	A <sub>1</sub>	A <sub>0</sub>	PSWP	RSWP	b <sub>7</sub> to b <sub>4</sub>	b <sub>3</sub>	b <sub>2</sub>	b <sub>1</sub>	b <sub>0</sub>						
Set PSWP	X	A <sub>2</sub>	A <sub>1</sub>	A <sub>0</sub>	1	X	0110	A <sub>2</sub>	A <sub>1</sub>	A <sub>0</sub>	X	No					
	GND	A <sub>2</sub>	A <sub>1</sub>	A <sub>0</sub>	0	X		A <sub>2</sub>	A <sub>1</sub>	A <sub>0</sub>	0	Yes	X	Yes	X	Yes	Yes
	V <sub>CC</sub>	A <sub>2</sub>	A <sub>1</sub>	A <sub>0</sub>	0	X		A <sub>2</sub>	A <sub>1</sub>	A <sub>0</sub>	0	Yes	X	Yes	X	No	No
	X	A <sub>2</sub>	A <sub>1</sub>	A <sub>0</sub>	0	X		A <sub>2</sub>	A <sub>1</sub>	A <sub>0</sub>	1	Yes					
Set RSWP	X	GND	GND	V <sub>HV</sub>	1	X		0	0	1	X	No					
	X	GND	GND	V <sub>HV</sub>	0	1		0	0	1	X	No					
	GND	GND	GND	V <sub>HV</sub>	0	0		0	0	1	0	Yes	X	Yes	X	Yes	Yes
	V <sub>CC</sub>	GND	GND	V <sub>HV</sub>	0	0		0	0	1	0	Yes	X	Yes	X	No	No
	X	GND	GND	V <sub>HV</sub>	0	0		0	0	1	1	Yes					
Clear RSWP	X	GND	V <sub>CC</sub>	V <sub>HV</sub>	1	X		0	1	1	X	No					
	GND	GND	V <sub>CC</sub>	V <sub>HV</sub>	0	X		0	1	1	0	Yes	X	Yes	X	Yes	Yes
	V <sub>CC</sub>	GND	V <sub>CC</sub>	V <sub>HV</sub>	0	X		0	1	1	0	Yes	X	Yes	X	No	No
	X	GND	V <sub>CC</sub>	V <sub>HV</sub>	0	X		0	1	1	1	Yes					

12. Here A<sub>2</sub>, A<sub>1</sub> and A<sub>0</sub> are either at V<sub>CC</sub> or GND.

13. 1 stands for 'Set', 0 stands for 'Not Set', X stands for 'don't care'.

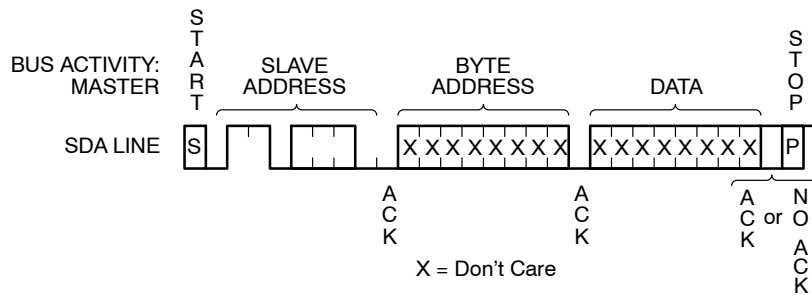

**Figure 14. Software Write Protect (Write)**

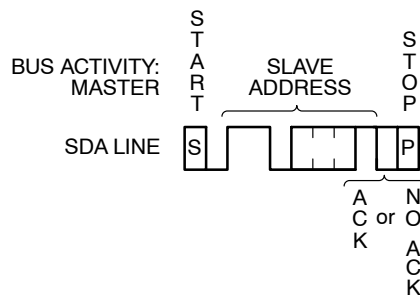
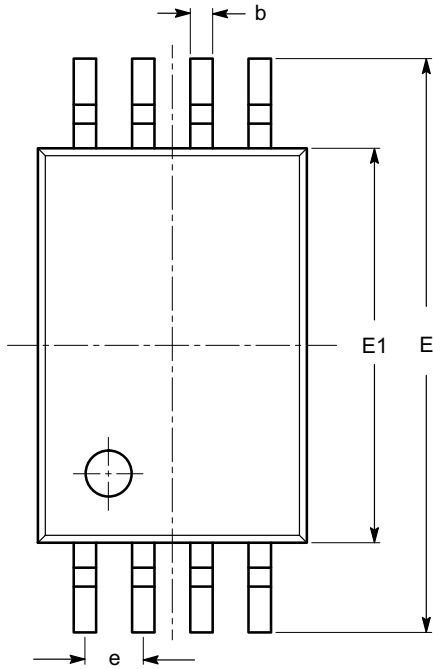

**Figure 15. Software Write Protect (Read)**

# CAT34C02

## PACKAGE DIMENSIONS

TSSOP8, 4.4x3  
CASE 948AL-01  
ISSUE O



SYMBOL	MIN	NOM	MAX
A			1.20
A1	0.05		0.15
A2	0.80	0.90	1.05
b	0.19		0.30
c	0.09		0.20
D	2.90	3.00	3.10
E	6.30	6.40	6.50
E1	4.30	4.40	4.50
e	0.65 BSC		
L	1.00 REF		
L1	0.50	0.60	0.75
$\theta$	0°		8°

TOP VIEW

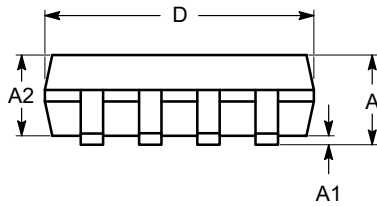

SIDE VIEW

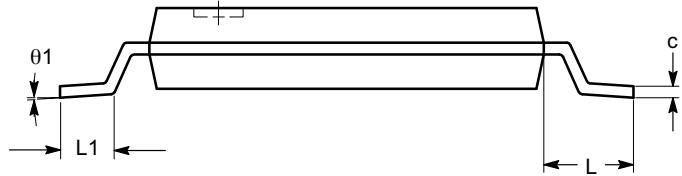

END VIEW

**Notes:**

- (1) All dimensions are in millimeters. Angles in degrees.
- (2) Complies with JEDEC MO-153.

# CAT34C02

## PACKAGE DIMENSIONS

TDFN8, 2x3  
CASE 511AK-01  
ISSUE A

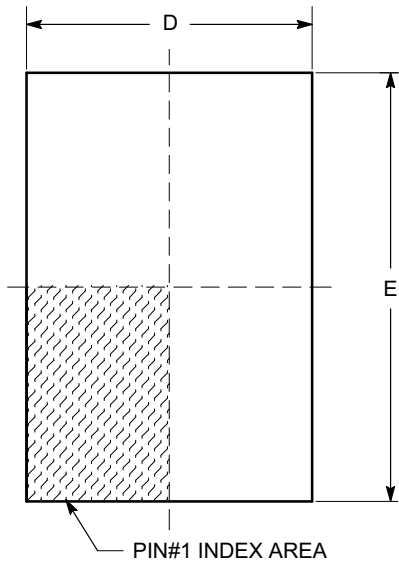

TOP VIEW

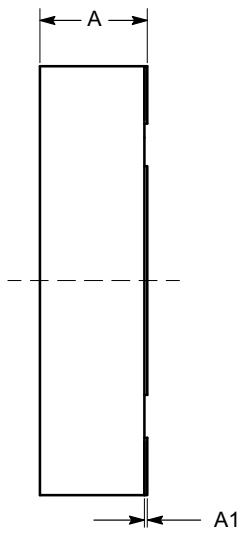

SIDE VIEW

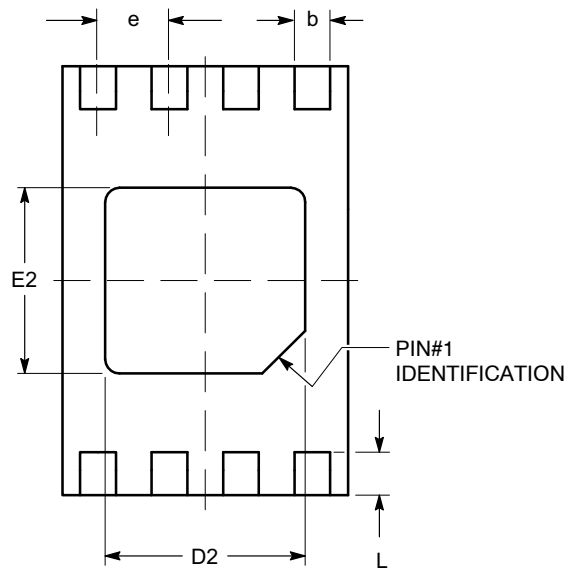

BOTTOM VIEW

SYMBOL	MIN	NOM	MAX
A	0.70	0.75	0.80
A1	0.00	0.02	0.05
A2	0.45	0.55	0.65
A3	0.20 REF		
b	0.20	0.25	0.30
D	1.90	2.00	2.10
D2	1.30	1.40	1.50
E	2.90	3.00	3.10
E2	1.20	1.30	1.40
e	0.50 TYP		
L	0.20	0.30	0.40

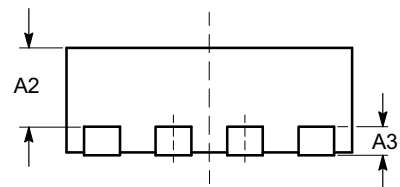

FRONT VIEW

**Notes:**

- (1) All dimensions are in millimeters.
- (2) Complies with JEDEC MO-229.

# CAT34C02

## PACKAGE DIMENSIONS

UDFN8, 2x3  
CASE 517AX-01  
ISSUE O

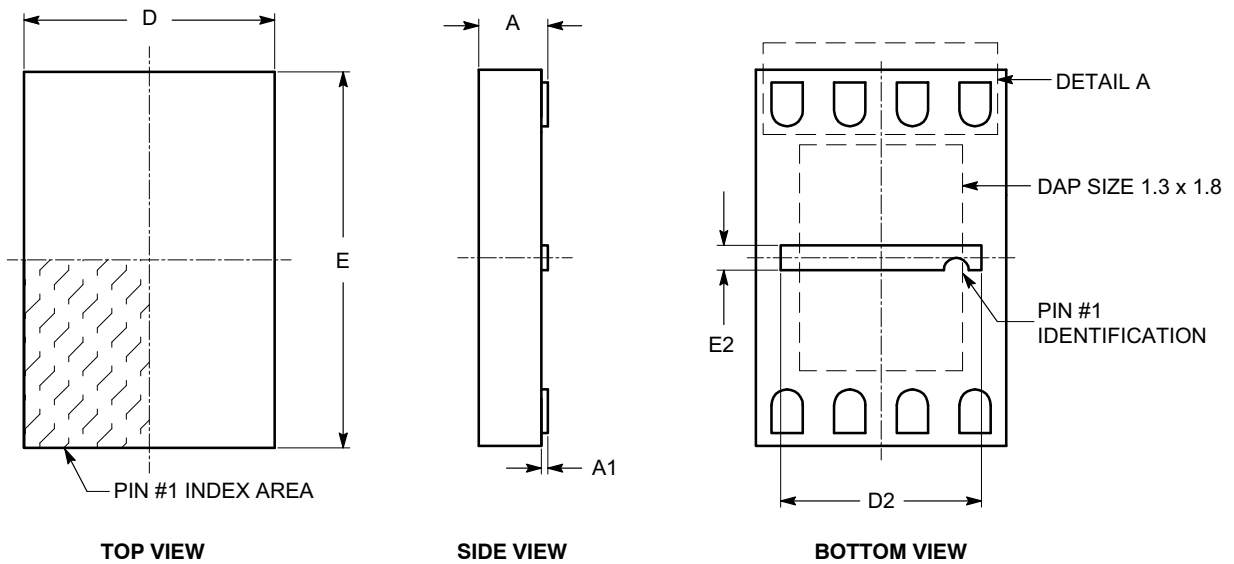

SYMBOL	MIN	NOM	MAX
A	0.45	0.50	0.55
A1	0.00	0.02	0.05
A3	0.127 REF		
b	0.20	0.25	0.30
D	1.90	2.00	2.10
D2	1.50	1.60	1.70
E	2.90	3.00	3.10
E2	0.10	0.20	0.30
e	0.50 TYP		
K	0.10 REF		
L	0.30	0.35	0.40

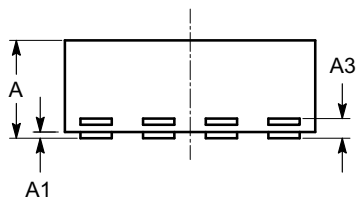
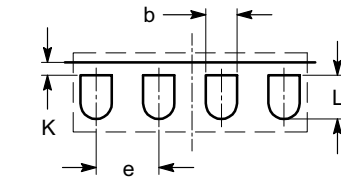

**Notes:**

- (1) All dimensions are in millimeters.
- (2) Complies with JEDEC MO-229.

# CAT34C02

## PACKAGE DIMENSIONS

UDFN8, 2x3 EXTENDED PAD  
CASE 517AZ-01  
ISSUE O

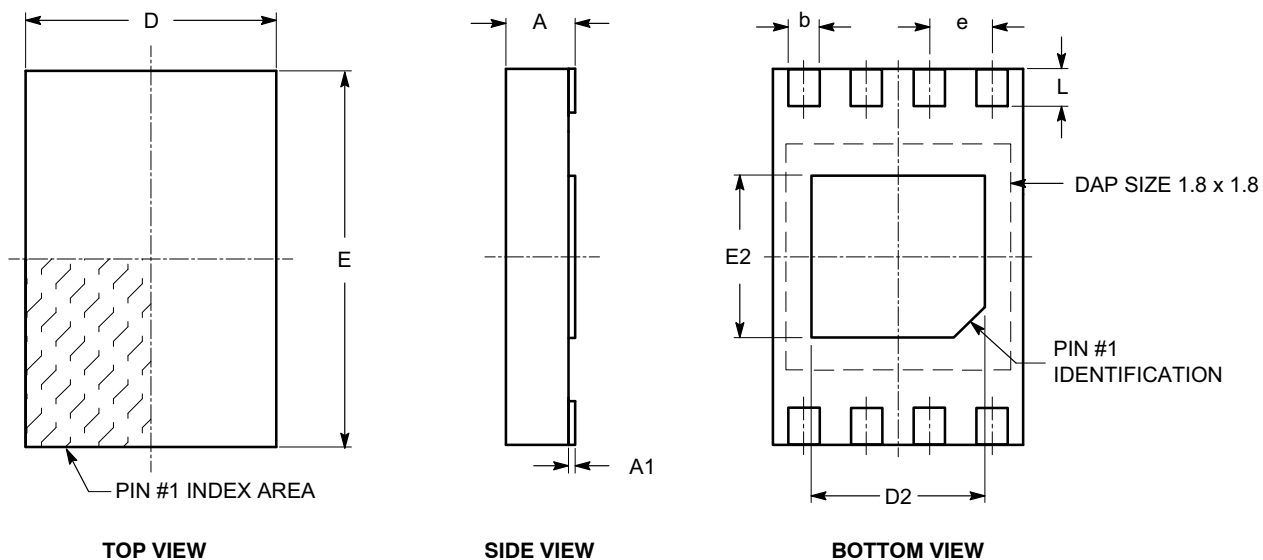

SYMBOL	MIN	NOM	MAX
A	0.45	0.50	0.55
A1	0.00	0.02	0.05
A3	0.127 REF		
b	0.20	0.25	0.30
D	1.95	2.00	2.05
D2	1.35	1.40	1.45
E	2.95	3.00	3.05
E2	1.25	1.30	1.35
e	0.50 REF		
L	0.25	0.30	0.35

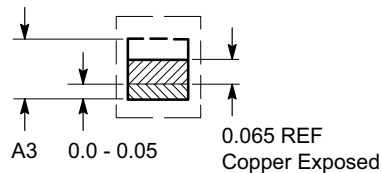
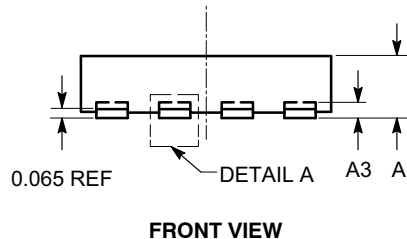

**Notes:**

- (1) All dimensions are in millimeters.
- (2) Refer JEDEC MO-236/MO-252.

1. ALL DIMENSIONS ARE IN MILLIMETERS.

# CAT34C02

## Example of Ordering Information

### CAT34C02 (Note 16)

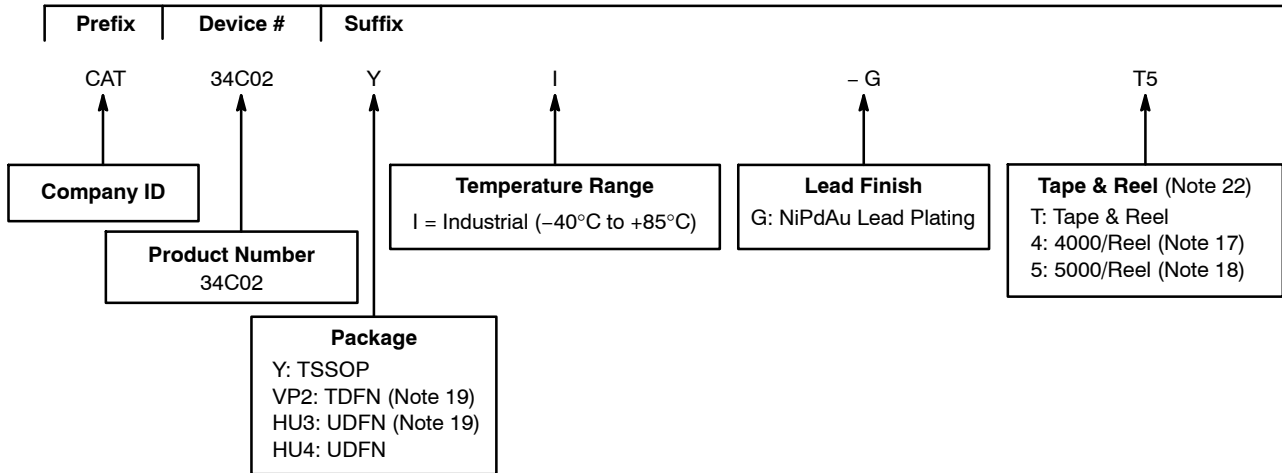

14. All packages are RoHS-compliant (Lead-free, Halogen-free)

15. The standard lead finish is NiPdAu.

16. The device used in the above example is a CAT34C02YI-GT5 (TSSOP, Industrial Temperature, NiPdAu, 5000 pcs / Reel)

17. The TDFN and UDFN packages are available in 4000 pcs/Reel (i.e., CAT34C02VP2I-GT4, CAT34C02HU3I-GT4, CAT34C02HU4I-GT4).

18. The TSSOP (Y) package (i.e., CAT34C02YI-GT5) is available in 5000 pcs / Reel.

19. Not recommended for new designs. Please replace with UDFN 2 x 3 mm (HU4) package.

20. **For Gresham ONLY die, please order the OPNs: CAT34C02YI-GT5A, CAT34C02VP2IGT4A, CAT34C02HU3IGT4A or CAT34C02HU4IGT4A.**

21. For additional package and temperature options, please contact your nearest ON Semiconductor Sales office.

22. For information on tape and reel specifications, including part orientation and tape sizes, please refer to our Tape and Reel Packaging Specifications Brochure, BRD8011/D.

ON Semiconductor is licensed by Philips Corporation to carry the I<sup>2</sup>C Bus Protocol.

ON Semiconductor and  are registered trademarks of Semiconductor Components Industries, LLC (SCILLC). SCILLC reserves the right to make changes without further notice to any products herein. SCILLC makes no warranty, representation or guarantee regarding the suitability of its products for any particular purpose, nor does SCILLC assume any liability arising out of the application or use of any product or circuit, and specifically disclaims any and all liability, including without limitation special, consequential or incidental damages. "Typical" parameters which may be provided in SCILLC data sheets and/or specifications can and do vary in different applications and actual performance may vary over time. All operating parameters, including "Typicals" must be validated for each customer application by customer's technical experts. SCILLC does not convey any license under its patent rights nor the rights of others. SCILLC products are not designed, intended, or authorized for use as components in systems intended for surgical implant into the body, or other applications intended to support or sustain life, or for any other application in which the failure of the SCILLC product could create a situation where personal injury or death may occur. Should Buyer purchase or use SCILLC products for any such unintended or unauthorized application, Buyer shall indemnify and hold SCILLC and its officers, employees, subsidiaries, affiliates, and distributors harmless against all claims, costs, damages, and expenses, and reasonable attorney fees arising out of, directly or indirectly, any claim of personal injury or death associated with such unintended or unauthorized use, even if such claim alleges that SCILLC was negligent regarding the design or manufacture of the part. SCILLC is an Equal Opportunity/Affirmative Action Employer. This literature is subject to all applicable copyright laws and is not for resale in any manner.

## PUBLICATION ORDERING INFORMATION

### LITERATURE FULFILLMENT:

Literature Distribution Center for ON Semiconductor  
P.O. Box 5163, Denver, Colorado 80217 USA  
Phone: 303-675-2175 or 800-344-3860 Toll Free USA/Canada  
Fax: 303-675-2176 or 800-344-3867 Toll Free USA/Canada  
Email: [orderlit@onsemi.com](mailto:orderlit@onsemi.com)

**N. American Technical Support:** 800-282-9855 Toll Free  
USA/Canada  
**Europe, Middle East and Africa Technical Support:**  
Phone: 421 33 790 2910  
**Japan Customer Focus Center**  
Phone: 81-3-5773-3850

**ON Semiconductor Website:** [www.onsemi.com](http://www.onsemi.com)

**Order Literature:** <http://www.onsemi.com/orderlit>

For additional information, please contact your local Sales Representative

# Mouser Electronics

Authorized Distributor

Click to View Pricing, Inventory, Delivery & Lifecycle Information:

## ON Semiconductor:

[CAT34C02VP2I-GT4](#) [CAT34C02HU4I-GT4](#) [CAT34C02VP2IGT4A](#) [CAT34C02YI-GT5A](#) [CAT34C02YI-GT5](#)  
[CAT34C02HU4IGT4A](#) [CAT34C02YI-G](#)