

BUV22

SWITCHMODE™ Series NPN Silicon Power Transistor

This device is designed for high speed, high current, high power applications.

Features

- High DC Current Gain:
 $h_{FE} \text{ min} = 20 \text{ at } I_C = 10 \text{ A}$
- Low $V_{CE(sat)}$, $V_{CE(sat)}$
 $\text{max} = 1.0 \text{ V at } I_C = 10 \text{ A}$
- Very Fast Switching Times:
 $TF \text{ max} = 0.35 \mu\text{s at } I_C = 20 \text{ A}$
- Pb-Free Package is Available*

MAXIMUM RATINGS

| Rating | Symbol | Value | Unit |
|---|----------------|------------|------------------|
| Collector-Emitter Voltage | $V_{CEO(SUS)}$ | 250 | Vdc |
| Collector-Base Voltage | V_{CBO} | 300 | Vdc |
| Emitter-Base Voltage | V_{EBO} | 7 | Vdc |
| Collector-Emitter Voltage ($V_{BE} = -1.5 \text{ V}$) | V_{CEX} | 300 | Vdc |
| Collector-Emitter Voltage ($R_{BE} = 100 \Omega$) | V_{CER} | 290 | Vdc |
| Collector-Current – Continuous | I_C | 40 | Adc |
| – Peak ($PW \leq 10 \text{ ms}$) | I_{CM} | 50 | Apk |
| Base-Current Continuous | I_B | 8 | Adc |
| Total Device Dissipation @ $T_C = 25^\circ\text{C}$ | P_D | 250 | W |
| Operating and Storage Junction Temperature Range | T_J, T_{stg} | -65 to 200 | $^\circ\text{C}$ |

THERMAL CHARACTERISTICS

| Characteristics | Symbol | Max | Unit |
|--------------------------------------|---------------|-----|--------------------|
| Thermal Resistance, Junction-to-Case | θ_{JC} | 0.7 | $^\circ\text{C/W}$ |

Maximum ratings are those values beyond which device damage can occur. Maximum ratings applied to the device are individual stress limit values (not normal operating conditions) and are not valid simultaneously. If these limits are exceeded, device functional operation is not implied, damage may occur and reliability may be affected.

*For additional information on our Pb-Free strategy and soldering details, please download the ON Semiconductor Soldering and Mounting Techniques Reference Manual, SOLDERRM/D.



ON Semiconductor®

<http://onsemi.com>

**40 AMPERES
NPN SILICON POWER
METAL TRANSISTOR
250 VOLTS – 250 WATTS**

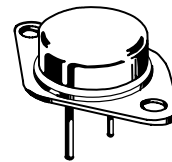

TO-204AE (TO-3)
CASE 197A

MARKING DIAGRAM



BUV22 = Device Code
 G = Pb-Free Package
 A = Assembly Location
 Y = Year
 WW = Work Week
 MEX = Country of Origin

ORDERING INFORMATION

| Device | Package | Shipping |
|--------|------------------|------------------|
| BUV22 | TO-204 | 100 Units / Tray |
| BUV22G | TO-204 (Pb-Free) | 100 Units / Tray |

BUV22

ELECTRICAL CHARACTERISTICS (T_C = 25°C unless otherwise noted)

| Characteristic | Symbol | Min | Max | Unit |
|--|-----------------------|-----|-------------|------|
| OFF CHARACTERISTICS (Note 1) | | | | |
| Collector–Emitter Sustaining Voltage (I _C = 200 mA, I _B = 0, L = 25 mH) | V _{CEO(sus)} | 250 | | Vdc |
| Collector Cutoff Current at Reverse Bias (V _{CE} = 300 V, V _{BE} = -1.5 V) (V _{CE} = 300 V, V _{BE} = -1.5 V, T _C = 125°C) | I _{CEx} | | 3.0 12.0 | mAdc |
| Collector–Emitter Cutoff Current (V _{CE} = 200 V) | I _{CEO} | | 3.0 | mAdc |
| Emitter–Base Reverse Voltage (I _E = 50 mA) | V _{EBO} | 7 | | V |
| Emitter–Cutoff Current (V _{EB} = 5 V) | I _{EBO} | | 1.0 | mAdc |

SECOND BREAKDOWN

| | | | | |
|--|------------------|------------|--|-----|
| Second Breakdown Collector Current with base forward biased (V _{CE} = 20 V, t = 1 s) (V _{CE} = 140 V, t = 1 s) | I _{S/b} | 12 0.15 | | Adc |
|--|------------------|------------|--|-----|

ON CHARACTERISTICS

 (Note 1)

| | | | | |
|--|----------------------|----------|------------|-----|
| DC Current Gain (I _C = 10 A, V _{CE} = 4 V) (I _C = 20 A, V _{CE} = 4 V) | h _{FE} | 20 10 | 60 | |
| Collector–Emitter Saturation Voltage (I _C = 10 A, I _B = 1 A) (I _C = 20 A, I _B = 2.5 A) | V _{CE(sat)} | | 1.0 1.5 | Vdc |
| Base–Emitter Saturation Voltage (I _C = 40 A, I _B = 4 A) | V _{BE(sat)} | | 1.5 | Vdc |

DYNAMIC CHARACTERISTICS

| | | | | |
|---|----------------|-----|--|-----|
| Current Gain — Bandwidth Product (V _{CE} = 15 V, I _C = 2 A, f = 4 MHz) | f _T | 8.0 | | MHz |
|---|----------------|-----|--|-----|

SWITCHING CHARACTERISTICS

 (Resistive Load)

| | | | | |
|--------------|--|-----------------|------|----|
| Turn-on Time | (I _C = 20 A, I _{B1} = I _{B2} = 2.5 A, V _{CC} = 100 V, R _C = 5 Ω) | t _{on} | 0.8 | μs |
| Storage Time | | t _s | 2.0 | |
| Fall Time | | t _f | 0.35 | |

1. Pulse Test: Pulse Width ≤ 300 μs, Duty Cycle ≤ 2%.

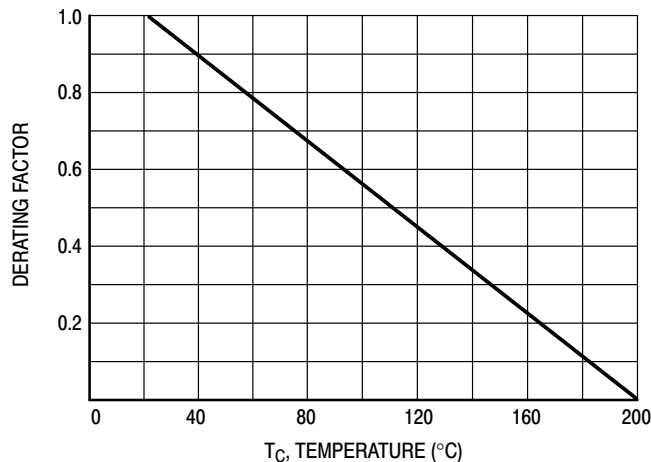

Figure 1. Power Derating

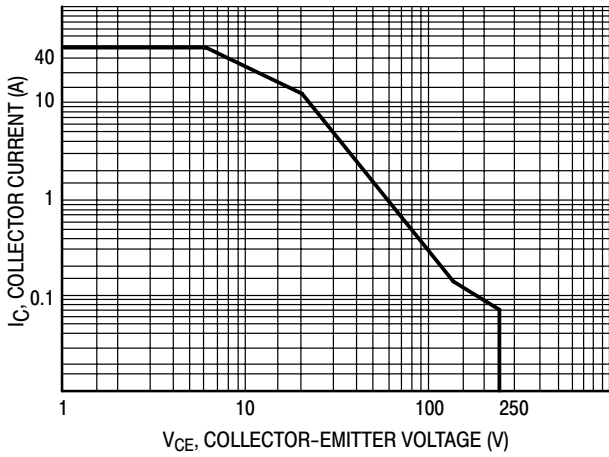

Figure 2. Active Region Safe Operating Area

There are two limitations on the power handling ability of a transistor: average junction temperature and second breakdown. Safe operating area curves indicate $I_C - V_{CE}$ limits of the transistor that must be observed for reliable operation i.e., the transistor must not be subjected to greater dissipation than the curves indicate.

The data of Figure 2 is based on $T_C = 25^\circ\text{C}$; $T_{J(pk)}$ is variable depending on power level. Second breakdown limitations do not derate the same as thermal limitations.

At high case temperatures, thermal limitations will reduce the power that can handled to values less than the limitations imposed by second breakdown.

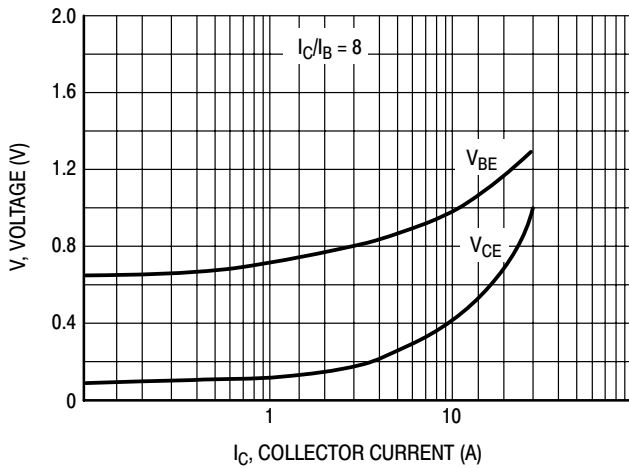

Figure 3. "On" Voltages

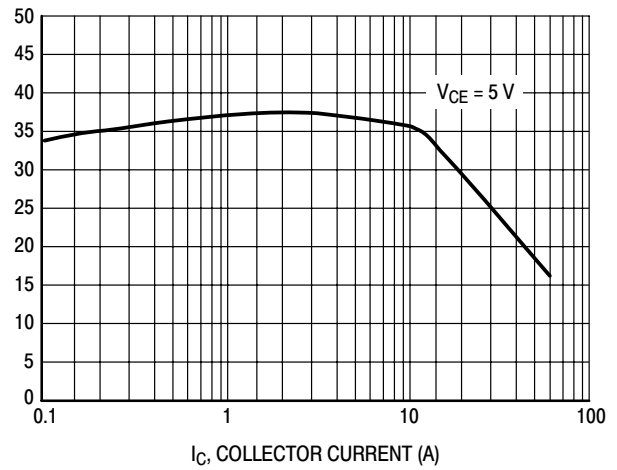

Figure 4. DC Current Gain

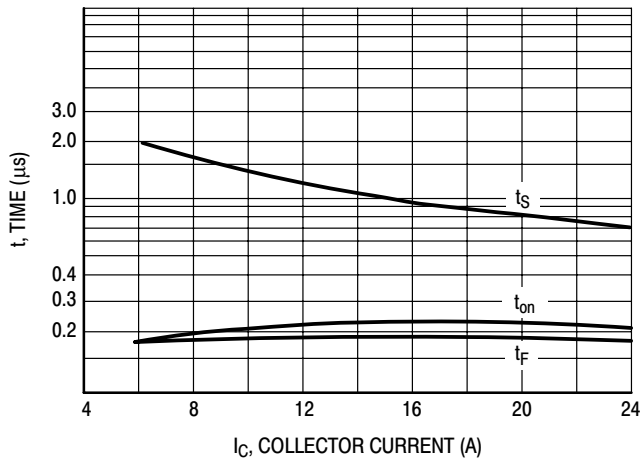

Figure 5. Resistive Switching Performance

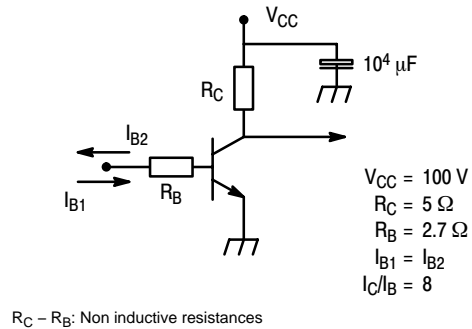
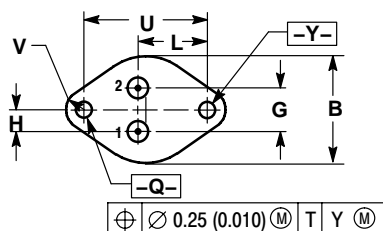
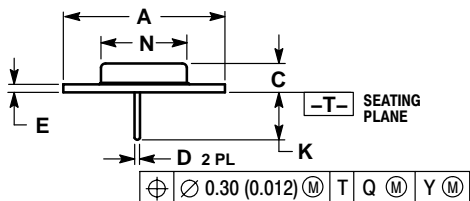

Figure 6. Switching Times Test Circuit

BUV22

PACKAGE DIMENSIONS

TO-204 (TO-3) CASE 197A-05 ISSUE K



- NOTES:
1. DIMENSIONING AND TOLERANCING PER ANSI Y14.5M, 1982.
2. CONTROLLING DIMENSION: INCH.

| DIM | INCHES | | MILLIMETERS | |
|-----|-----------|-------|-------------|-------|
| | MIN | MAX | MIN | MAX |
| A | 1.530 REF | | 38.86 REF | |
| B | 0.990 | 1.050 | 25.15 | 26.67 |
| C | 0.250 | 0.335 | 6.35 | 8.51 |
| D | 0.057 | 0.063 | 1.45 | 1.60 |
| E | 0.060 | 0.070 | 1.53 | 1.77 |
| G | 0.430 BSC | | 10.92 BSC | |
| H | 0.215 BSC | | 5.46 BSC | |
| K | 0.440 | 0.480 | 11.18 | 12.19 |
| L | 0.665 BSC | | 16.89 BSC | |
| N | 0.760 | 0.830 | 19.31 | 21.08 |
| Q | 0.151 | 0.165 | 3.84 | 4.19 |
| U | 1.187 BSC | | 30.15 BSC | |
| V | 0.131 | 0.188 | 3.33 | 4.77 |

SWITCHMODE is a trademark of Semiconductor Components Industries, LLC.

ON Semiconductor and  are registered trademarks of Semiconductor Components Industries, LLC (SCILLC). SCILLC reserves the right to make changes without further notice to any products herein. SCILLC makes no warranty, representation or guarantee regarding the suitability of its products for any particular purpose, nor does SCILLC assume any liability arising out of the application or use of any product or circuit, and specifically disclaims any and all liability, including without limitation special, consequential or incidental damages. "Typical" parameters which may be provided in SCILLC data sheets and/or specifications can and do vary in different applications and actual performance may vary over time. All operating parameters, including "Typicals" must be validated for each customer application by customer's technical experts. SCILLC does not convey any license under its patent rights nor the rights of others. SCILLC products are not designed, intended, or authorized for use as components in systems intended for surgical implant into the body, or other applications intended to support or sustain life, or for any other application in which the failure of the SCILLC product could create a situation where personal injury or death may occur. Should Buyer purchase or use SCILLC products for any such unintended or unauthorized application, Buyer shall indemnify and hold SCILLC and its officers, employees, subsidiaries, affiliates, and distributors harmless against all claims, costs, damages, and expenses, and reasonable attorney fees arising out of, directly or indirectly, any claim of personal injury or death associated with such unintended or unauthorized use, even if such claim alleges that SCILLC was negligent regarding the design or manufacture of the part. SCILLC is an Equal Opportunity/Affirmative Action Employer. This literature is subject to all applicable copyright laws and is not for resale in any manner.

PUBLICATION ORDERING INFORMATION

LITERATURE FULFILLMENT:
Literature Distribution Center for ON Semiconductor
P.O. Box 61312, Phoenix, Arizona 85082-1312 USA
Phone: 480-829-7710 or 800-344-3860 Toll Free USA/Canada
Fax: 480-829-7709 or 800-344-3867 Toll Free USA/Canada
Email: orderlit@onsemi.com

N. American Technical Support: 800-282-9855 Toll Free
USA/Canada

Japan: ON Semiconductor, Japan Customer Focus Center
2-9-1 Kamimeguro, Meguro-ku, Tokyo, Japan 153-0051
Phone: 81-3-5773-3850

ON Semiconductor Website: <http://onsemi.com>

Order Literature: <http://www.onsemi.com/litorder>

For additional information, please contact your local Sales Representative.

Mouser Electronics

Authorized Distributor

Click to View Pricing, Inventory, Delivery & Lifecycle Information:

[ON Semiconductor:](#)

[BUV22G](#)