

# MOSFET

## 500V CoolMOS™ CE Power Transistor

CoolMOS™ is a revolutionary technology for high voltage power MOSFETs, designed according to the superjunction (SJ) principle and pioneered by Infineon Technologies. CoolMOS™ CE is a price-performance optimized platform enabling to target cost sensitive applications in Consumer and Lighting markets by still meeting highest efficiency standards. The new series provides all benefits of a fast switching Superjunction MOSFET while not sacrificing ease of use and offering the best cost down performance ratio available on the market.

### Features

- Extremely low losses due to very low FOM  $R_{DS(on)} \cdot Q_g$  and  $E_{oss}$
- Very high commutation ruggedness
- Easy to use/drive
- Pb-free plating, Halogen free mold compound
- Qualified for standard grade applications

### Applications

Adapter, Charger and Lighting

*Please note: For MOSFET paralleling the use of ferrite beads on the gate or separate totem poles is generally recommended.*

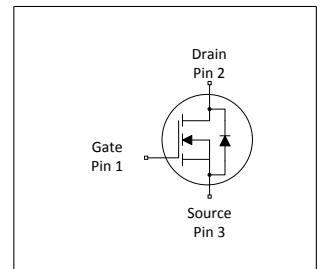
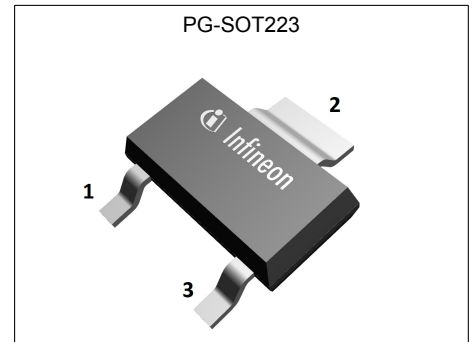

**Table 1 Key Performance Parameters**

Parameter	Value	Unit
$V_{DS} @ T_{j,max}$	550	V
$R_{DS(on),max}$	0.8	$\Omega$
$I_D$	7.6	A
$Q_{g,typ}$	12.4	nC
$I_{D,pulse}$	15.5	A
$E_{oss} @ 400V$	1.46	$\mu J$

Type / Ordering Code	Package	Marking	Related Links
IPN50R800CE	PG-SOT223	50S800	see Appendix A

## Table of Contents

Description .....	1
Maximum ratings .....	3
Thermal characteristics .....	3
Electrical characteristics .....	4
Electrical characteristics diagrams .....	6
Test Circuits .....	10
Package Outlines .....	11
Appendix A .....	12
Revision History .....	13
Trademarks .....	13
Disclaimer .....	13

## 1 Maximum ratings

at  $T_j = 25^\circ\text{C}$ , unless otherwise specified

**Table 2 Maximum ratings**

Parameter	Symbol	Values			Unit	Note / Test Condition
		Min.	Typ.	Max.		
Continuous drain current <sup>1)</sup>	$I_D$	-	-	7.6 4.8	A	$T_C = 25^\circ\text{C}$ $T_C = 100^\circ\text{C}$
Pulsed drain current <sup>2)</sup>	$I_{D,pulse}$	-	-	15.5	A	$T_C = 25^\circ\text{C}$
Avalanche energy, single pulse	$E_{AS}$	-	-	83	mJ	$I_D = 1.9\text{A}$ ; $V_{DD} = 50\text{V}$
Avalanche energy, repetitive	$E_{AR}$	-	-	0.13	mJ	$I_D = 1.9\text{A}$ ; $V_{DD} = 50\text{V}$
Avalanche current, repetitive	$I_{AR}$	-	-	1.9	A	-
MOSFET dv/dt ruggedness	dv/dt	-	-	50	V/ns	$V_{DS} = 0 \dots 400\text{V}$
Gate source voltage	$V_{GS}$	-20 -30	-	20 30	V	static; AC ( $f > 1\text{ Hz}$ )
Power dissipation	$P_{tot}$	-	-	5.0	W	$T_C = 25^\circ\text{C}$
Operating and storage temperature	$T_j, T_{stg}$	-40	-	150	$^\circ\text{C}$	-
Continuous diode forward current	$I_S$	-	-	1.6	A	$T_C = 25^\circ\text{C}$
Diode pulse current <sup>2)</sup>	$I_{S,pulse}$	-	-	15.5	A	$T_C = 25^\circ\text{C}$
Reverse diode dv/dt <sup>3)</sup>	dv/dt	-	-	15	V/ns	$V_{DS} = 0 \dots 400\text{V}$ , $I_{SD} \leq I_S$ , $T_j = 25^\circ\text{C}$ , $t_{cond} < 2\mu\text{s}$
Maximum diode commutation speed <sup>3)</sup>	di/dt	-	-	500	A/ $\mu\text{s}$	$V_{DS} = 0 \dots 400\text{V}$ , $I_{SD} \leq I_S$ , $T_j = 25^\circ\text{C}$ , $t_{cond} < 2\mu\text{s}$

## 2 Thermal characteristics

**Table 3 Thermal characteristics**

Parameter	Symbol	Values			Unit	Note / Test Condition
		Min.	Typ.	Max.		
Thermal resistance, junction - solder point	$R_{thJS}$	-	-	23.2	$^\circ\text{C/W}$	-
Thermal resistance, junction - ambient for minimal footprint	$R_{thJA}$	-	-	160	$^\circ\text{C/W}$	minimal footprint
Thermal resistance, junction - ambient soldered on copper area	$R_{thJA}$	-	-	75	$^\circ\text{C/W}$	Device on 40mm*40mm*1.5 epoxy PCB FR4 with 6cm <sup>2</sup> (one layer 70 $\mu\text{m}$ thick) copper area for drain connection and cooling. PCB is vertical without blown air.
Soldering temperature, wavesoldering only allowed at leads	$T_{sold}$	-	-	260	$^\circ\text{C}$	reflow MSL3

<sup>1)</sup> DPAK equivalent. Limited by  $T_{j,max}$ . Maximum duty cycle  $D=0.5$

<sup>2)</sup> Pulse width  $t_p$  limited by  $T_{j,max}$

<sup>3)</sup>  $V_{DClink}=400\text{V}$ ;  $V_{DS,peak} < V_{(BR)DSS}$ ; identical low side and high side switch with identical  $R_G$

### 3 Electrical characteristics

**Table 4 Static characteristics**

Parameter	Symbol	Values			Unit	Note / Test Condition
		Min.	Typ.	Max.		
Drain-source breakdown voltage	$V_{(BR)DSS}$	500	-	-	V	$V_{GS}=0V, I_D=1mA$
Gate threshold voltage	$V_{GS(th)}$	2.50	3	3.50	V	$V_{DS}=V_{GS}, I_D=0.13mA$
Zero gate voltage drain current	$I_{DSS}$	-	-	1	$\mu A$	$V_{DS}=500V, V_{GS}=0V, T_j=25^\circ C$ $V_{DS}=500V, V_{GS}=0V, T_j=150^\circ C$
Gate-source leakage current	$I_{GSS}$	-	-	100	nA	$V_{GS}=20V, V_{DS}=0V$
Drain-source on-state resistance	$R_{DS(on)}$	-	0.72	0.80	$\Omega$	$V_{GS}=13V, I_D=1.5A, T_j=25^\circ C$ $V_{GS}=13V, I_D=1.5A, T_j=150^\circ C$
Gate resistance	$R_G$	-	3	-	$\Omega$	$f=1\text{ MHz, open drain}$

**Table 5 Dynamic characteristics**

Parameter	Symbol	Values			Unit	Note / Test Condition
		Min.	Typ.	Max.		
Input capacitance	$C_{iss}$	-	280	-	pF	$V_{GS}=0V, V_{DS}=100V, f=1MHz$
Output capacitance	$C_{oss}$	-	23	-	pF	$V_{GS}=0V, V_{DS}=100V, f=1MHz$
Effective output capacitance, energy related <sup>1)</sup>	$C_{o(er)}$	-	18	-	pF	$V_{GS}=0V, V_{DS}=0...400V$
Effective output capacitance, time related <sup>2)</sup>	$C_{o(tr)}$	-	67	-	pF	$I_D=constant, V_{GS}=0V, V_{DS}=0...400V$
Turn-on delay time	$t_{d(on)}$	-	6.2	-	ns	$V_{DD}=400V, V_{GS}=13V, I_D=1.9A,$ $R_G=5.3\Omega$
Rise time	$t_r$	-	5.5	-	ns	$V_{DD}=400V, V_{GS}=13V, I_D=1.9A,$ $R_G=5.3\Omega$
Turn-off delay time	$t_{d(off)}$	-	26	-	ns	$V_{DD}=400V, V_{GS}=13V, I_D=1.9A,$ $R_G=5.3\Omega$
Fall time	$t_f$	-	15.9	-	ns	$V_{DD}=400V, V_{GS}=13V, I_D=1.9A,$ $R_G=5.3\Omega$

**Table 6 Gate charge characteristics**

Parameter	Symbol	Values			Unit	Note / Test Condition
		Min.	Typ.	Max.		
Gate to source charge	$Q_{gs}$	-	1.5	-	nC	$V_{DD}=400V, I_D=1.9A, V_{GS}=0\text{ to }10V$
Gate to drain charge	$Q_{gd}$	-	6.8	-	nC	$V_{DD}=400V, I_D=1.9A, V_{GS}=0\text{ to }10V$
Gate charge total	$Q_g$	-	12.4	-	nC	$V_{DD}=400V, I_D=1.9A, V_{GS}=0\text{ to }10V$
Gate plateau voltage	$V_{plateau}$	-	5.3	-	V	$V_{DD}=400V, I_D=1.9A, V_{GS}=0\text{ to }10V$

<sup>1)</sup>  $C_{o(er)}$  is a fixed capacitance that gives the same stored energy as  $C_{oss}$  while  $V_{DS}$  is rising from 0 to 400V

<sup>2)</sup>  $C_{o(tr)}$  is a fixed capacitance that gives the same charging time as  $C_{oss}$  while  $V_{DS}$  is rising from 0 to 400V

Table 7 Reverse diode characteristics

Parameter	Symbol	Values			Unit	Note / Test Condition
		Min.	Typ.	Max.		
Diode forward voltage	$V_{SD}$	-	0.83	-	V	$V_{GS}=0V, I_F=1.9A, T_i=25^{\circ}C$
Reverse recovery time	$t_{rr}$	-	158	-	ns	$V_R=400V, I_F=1.9A, di_F/dt=100A/\mu s$
Reverse recovery charge	$Q_{rr}$	-	0.84	-	$\mu C$	$V_R=400V, I_F=1.9A, di_F/dt=100A/\mu s$
Peak reverse recovery current	$I_{rrm}$	-	9.6	-	A	$V_R=400V, I_F=1.9A, di_F/dt=100A/\mu s$

### 4 Electrical characteristics diagrams

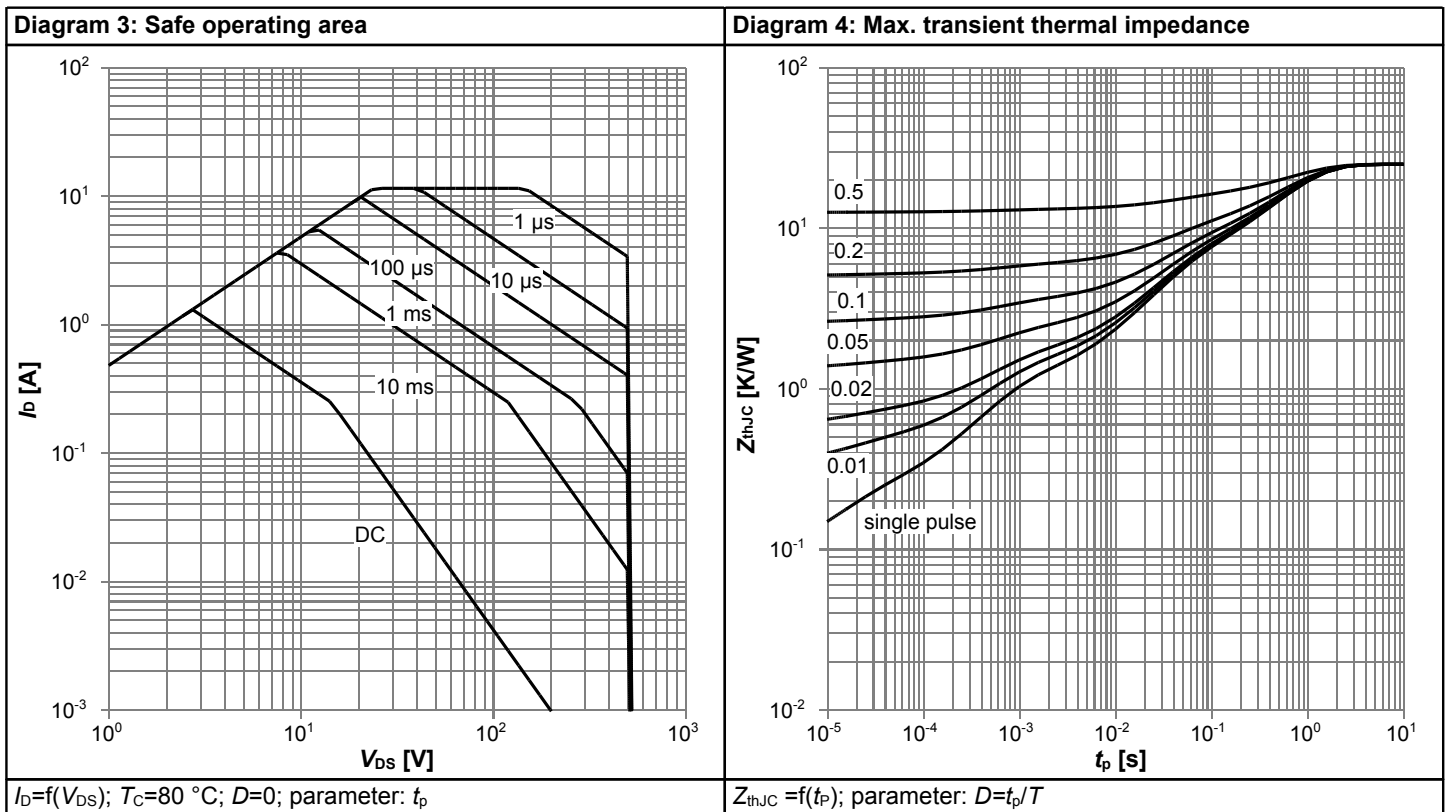
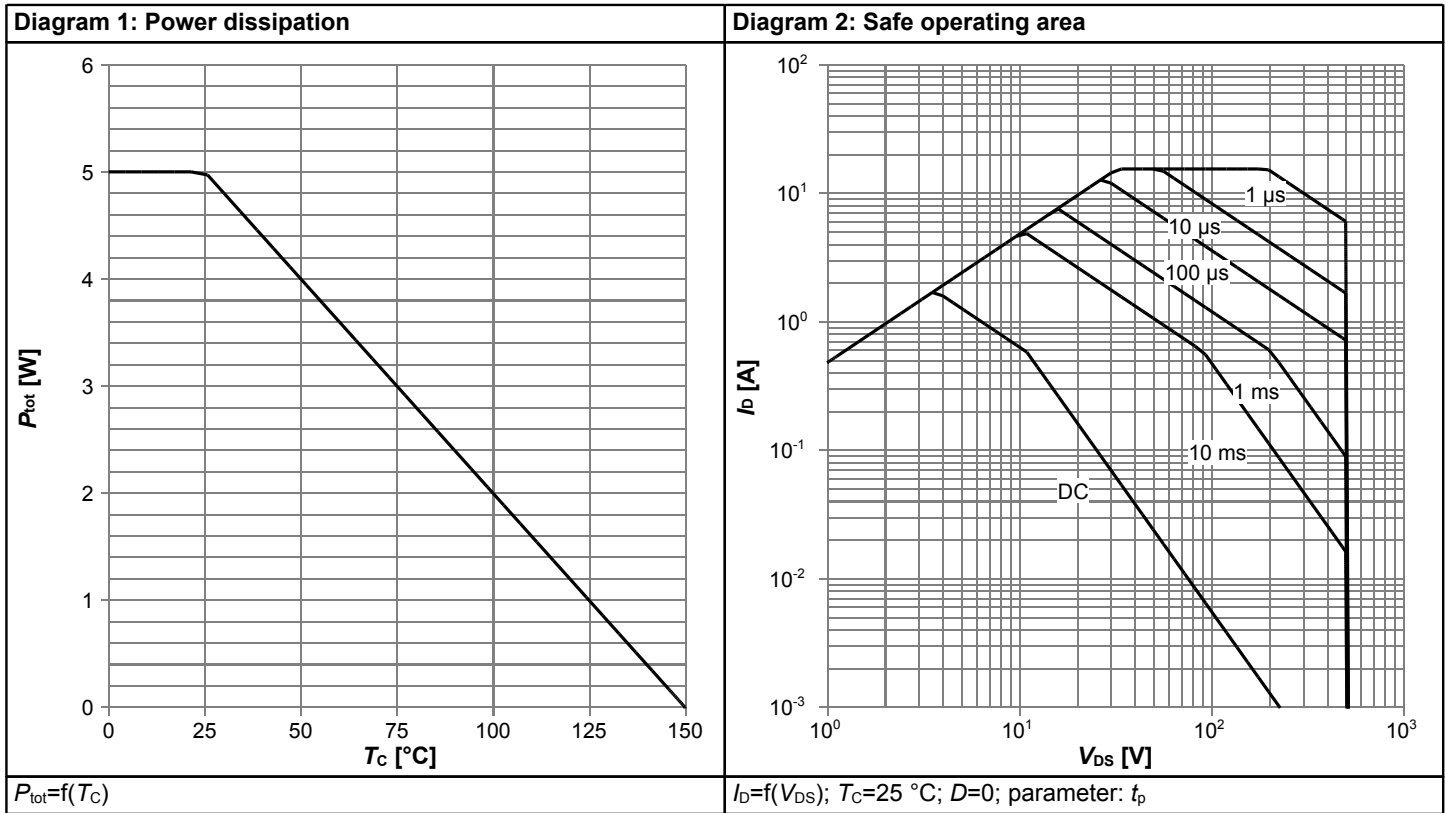

# 500V CoolMOS™ CE Power Transistor

## IPN50R800CE

Diagram 5: Typ. output characteristics

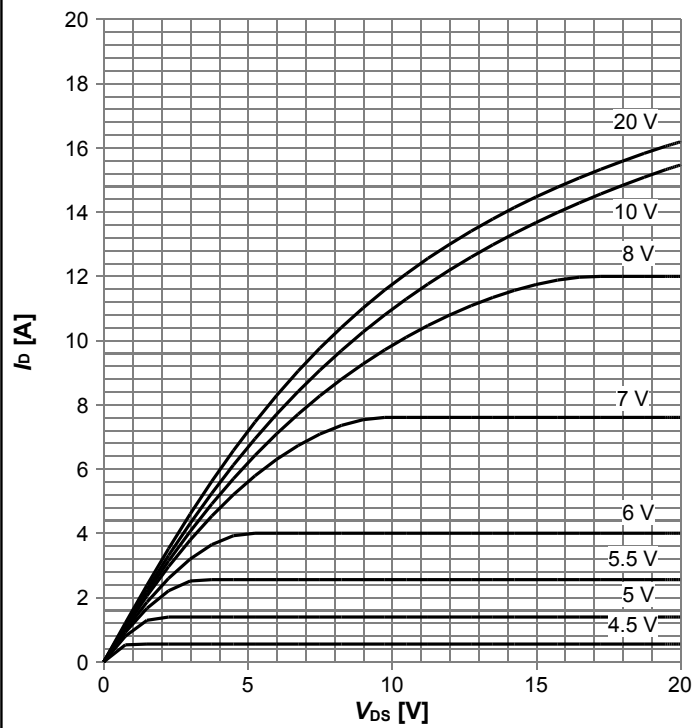

$I_D=f(V_{DS})$ ;  $T_j=25\text{ °C}$ ; parameter:  $V_{GS}$

Diagram 6: Typ. output characteristics

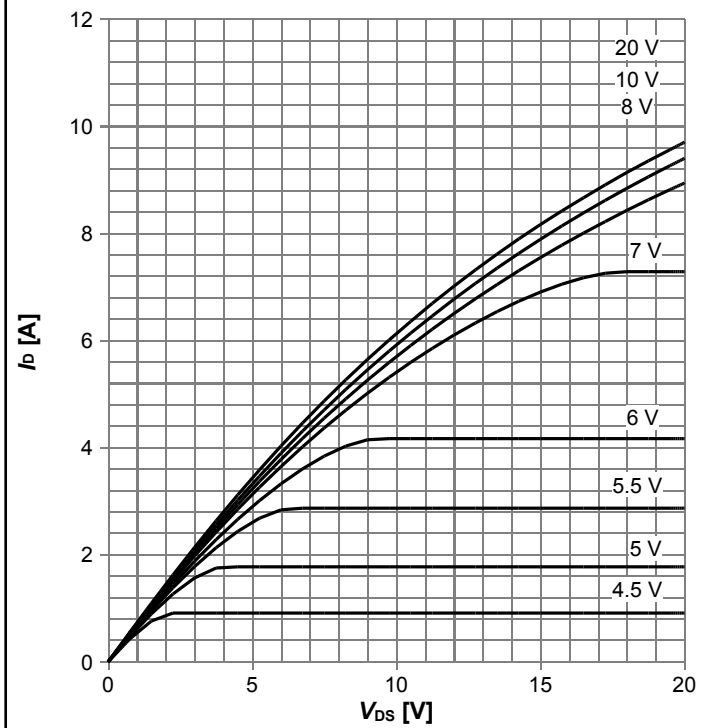

$I_D=f(V_{DS})$ ;  $T_j=125\text{ °C}$ ; parameter:  $V_{GS}$

Diagram 7: Typ. drain-source on-state resistance

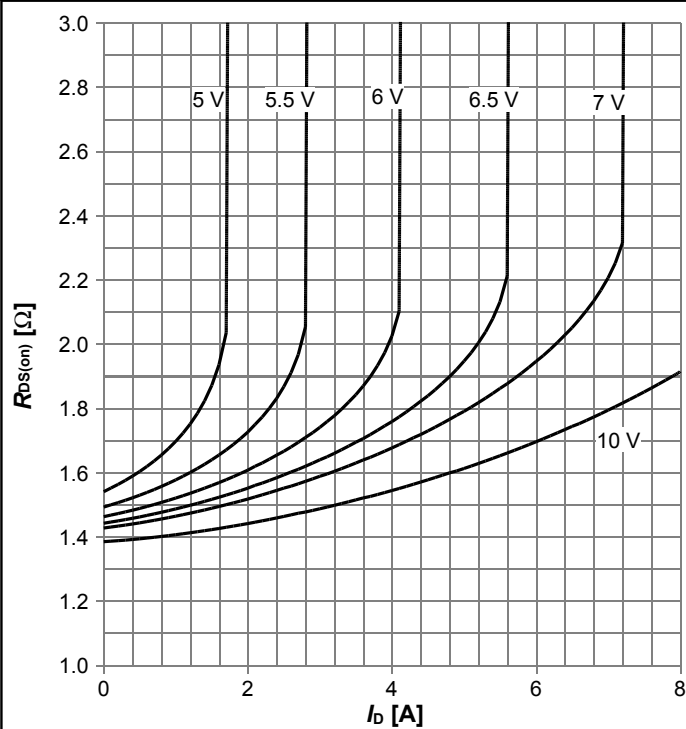

$R_{DS(on)}=f(I_D)$ ;  $T_j=125\text{ °C}$ ; parameter:  $V_{GS}$

Diagram 8: Drain-source on-state resistance

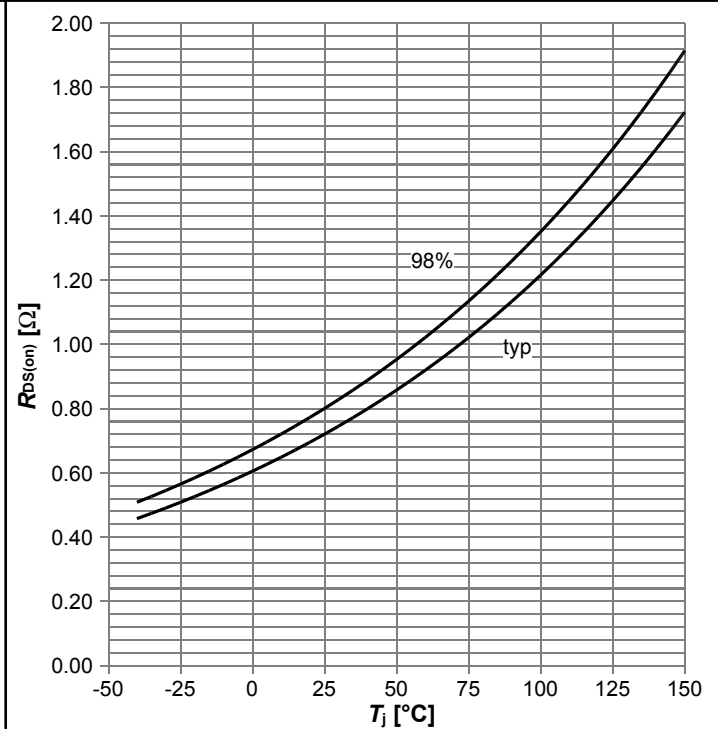

$R_{DS(on)}=f(T_j)$ ;  $I_D=1.5\text{ A}$ ;  $V_{GS}=13\text{ V}$

# 500V CoolMOS™ CE Power Transistor IPN50R800CE

**Diagram 9: Typ. transfer characteristics**

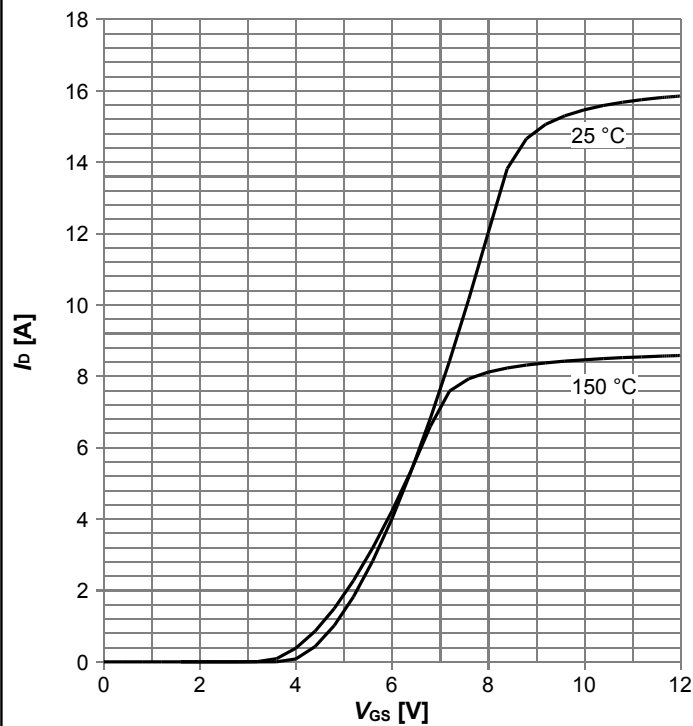

$I_D = f(V_{GS})$ ;  $V_{DS} = 20V$ ; parameter:  $T_j$

**Diagram 10: Typ. gate charge**

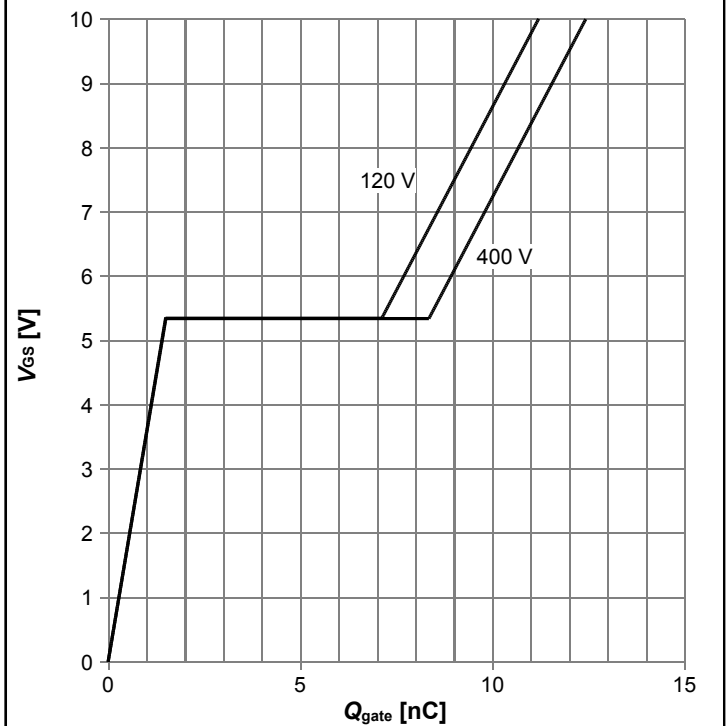

$V_{GS} = f(Q_{gate})$ ;  $I_D = 1.9 A$  pulsed; parameter:  $V_{DD}$

**Diagram 11: Forward characteristics of reverse diode**

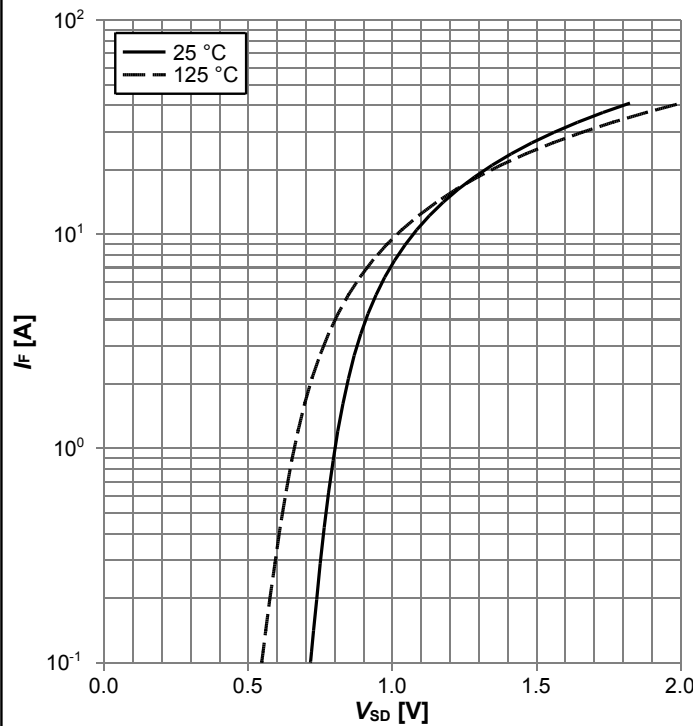

$I_F = f(V_{SD})$ ; parameter:  $T_j$

**Diagram 12: Avalanche energy**

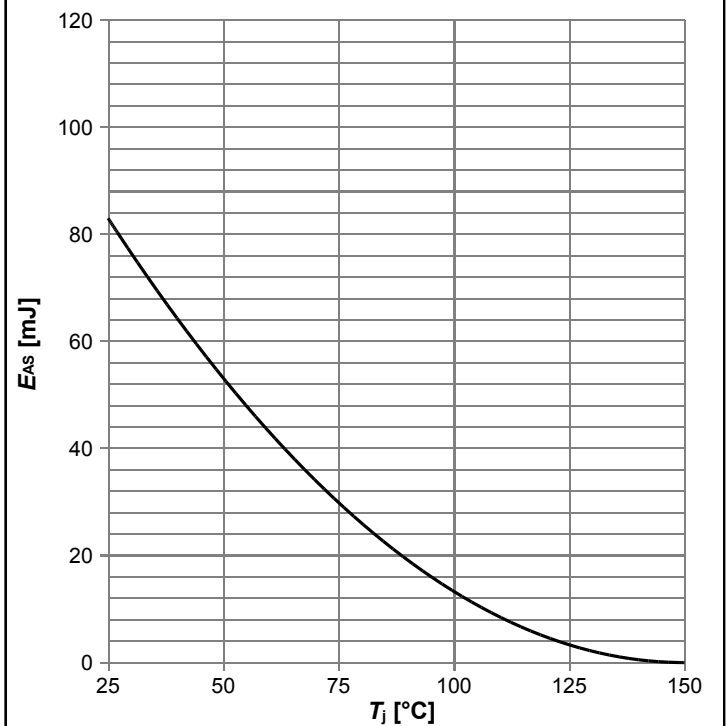

$E_{AS} = f(T_j)$ ;  $I_D = 1.9 A$ ;  $V_{DD} = 50 V$



**500V CoolMOS™ CE Power Transistor**  
**IPN50R800CE**

**Diagram 13: Drain-source breakdown voltage**

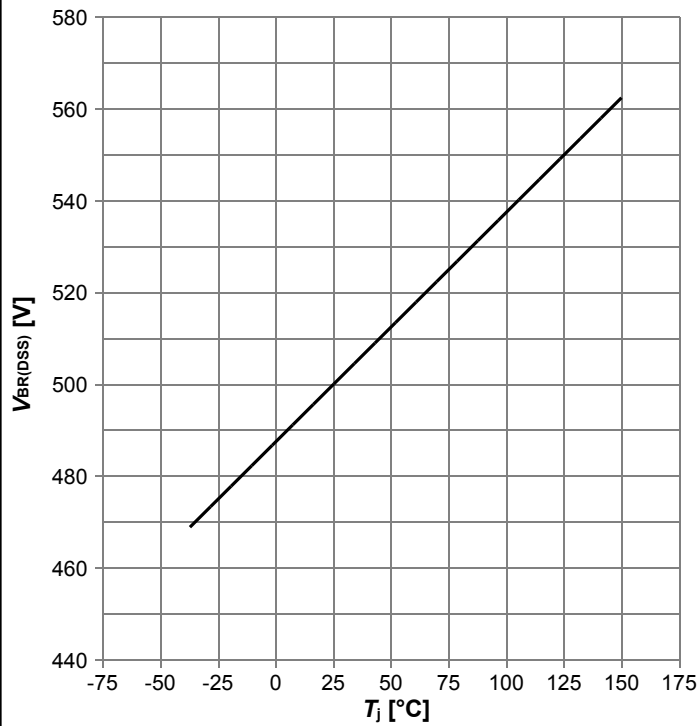

$V_{BR(DSS)}=f(T_j); I_D=1\text{ mA}$

**Diagram 14: Typ. capacitances**

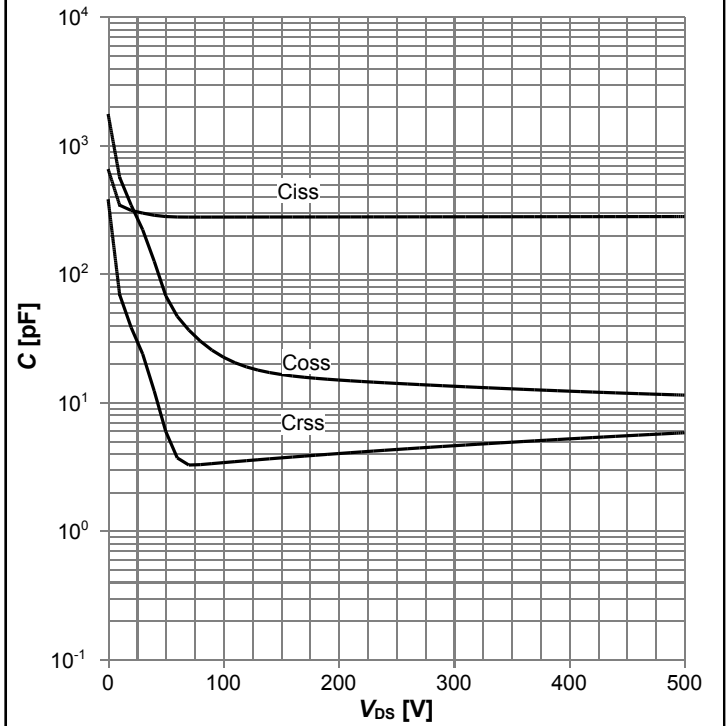

$C=f(V_{DS}); V_{GS}=0\text{ V}; f=1\text{ MHz}$

**Diagram 15: Typ. Coss stored energy**

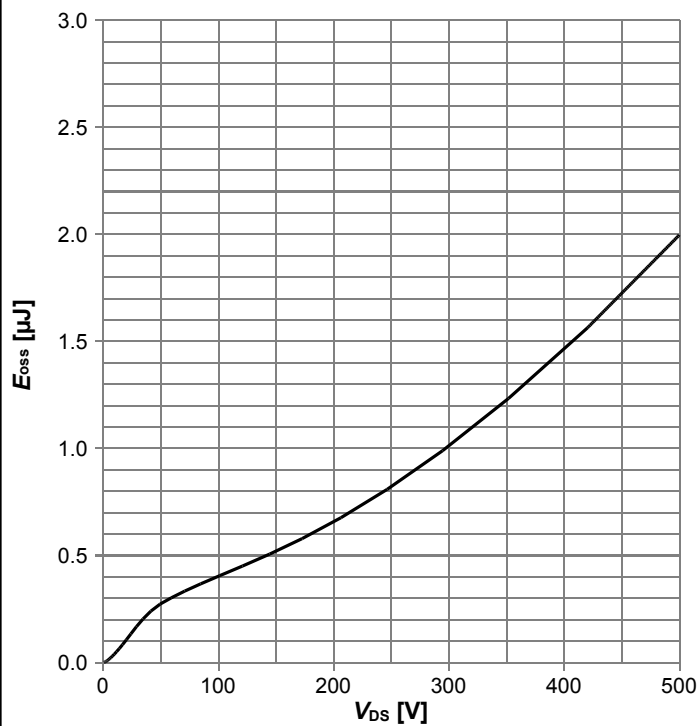

$E_{oss}=f(V_{DS})$

## 5 Test Circuits

**Table 8 Diode characteristics**

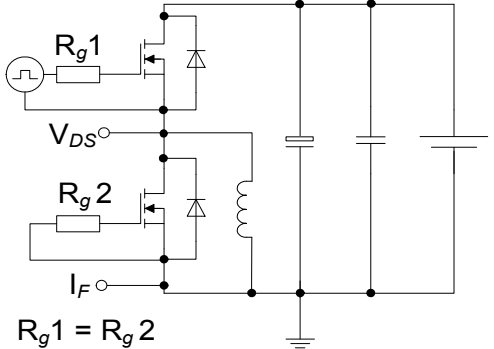
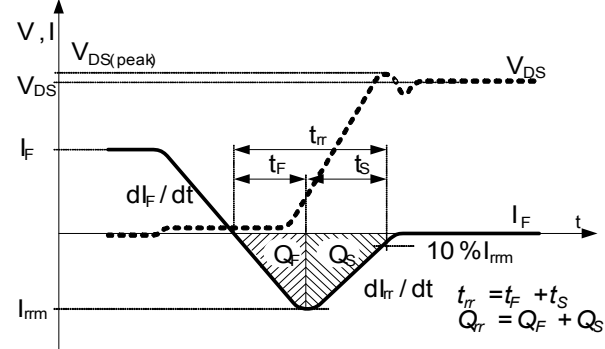
Test circuit for diode characteristics	Diode recovery waveform
 <p><math>R_{g1} = R_{g2}</math></p>	 <p><math>t_{tr} = t_{fr} + t_s</math>  <math>Q_{rr} = Q_F + Q_S</math></p>

**Table 9 Switching times**

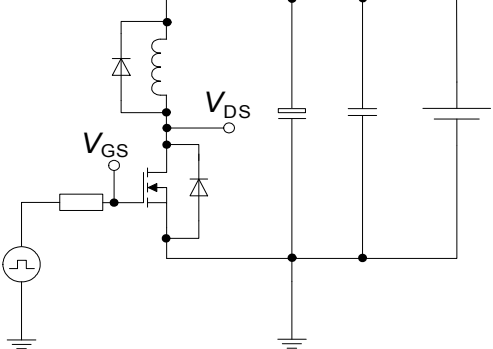
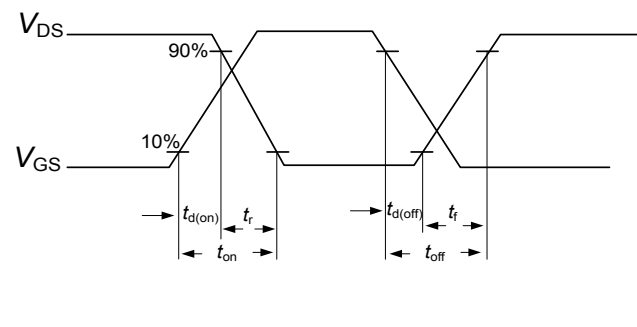
Switching times test circuit for inductive load	Switching times waveform
	

**Table 10 Unclamped inductive load**

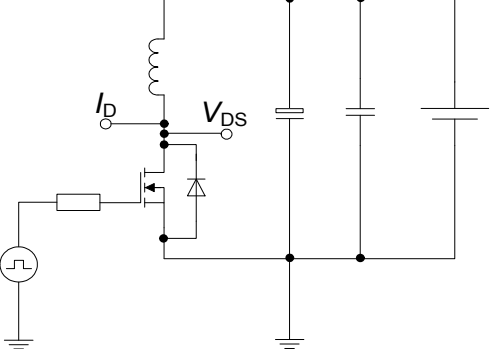
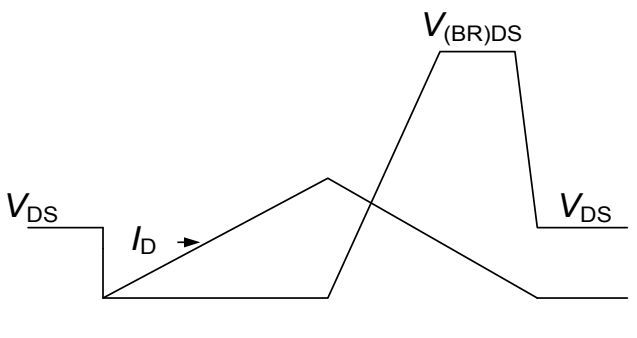
Unclamped inductive load test circuit	Unclamped inductive waveform
	

## 6 Package Outlines

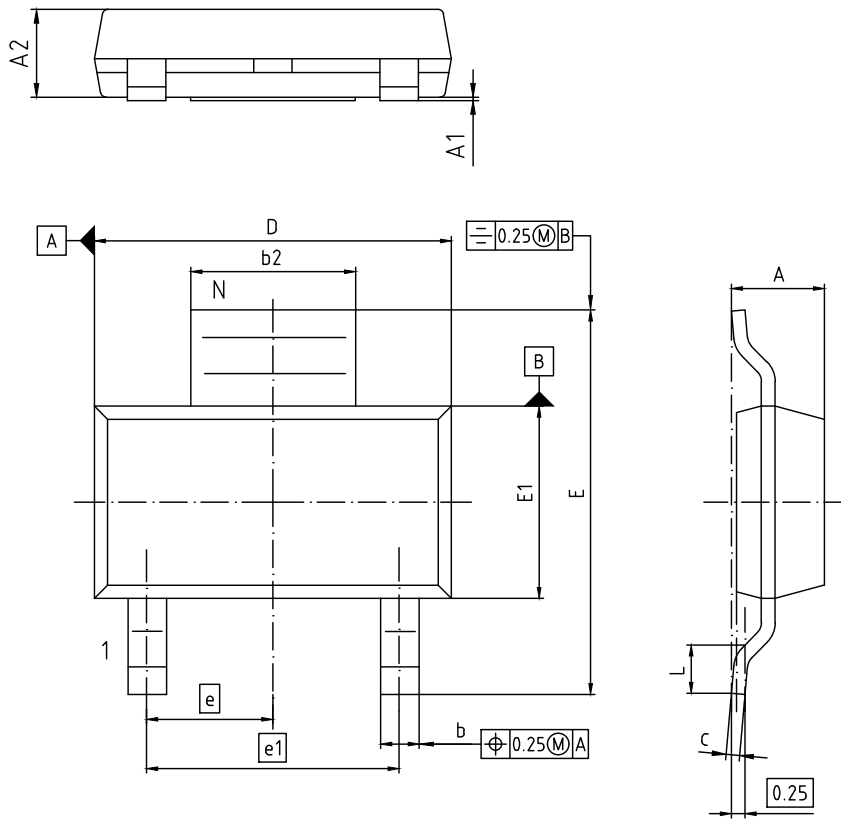

NOTES:

1. ALL DIMENSIONS REFER TO JEDEC STANDARD TO-261

DIM	MILLIMETERS		INCHES	
	MIN	MAX	MIN	MAX
A	1.52	1.80	0.060	0.071
A1	-	0.10	-	0.004
A2	1.50	1.70	0.059	0.067
b	0.60	0.80	0.024	0.031
b2	2.95	3.10	0.116	0.122
c	0.24	0.32	0.009	0.013
D	6.30	6.70	0.248	0.264
E	6.70	7.30	0.264	0.287
E1	3.30	3.70	0.130	0.146
e	2.3 BASIC		0.091 BASIC	
e1	4.6 BASIC		0.181 BASIC	
L	0.75	1.10	0.030	0.043
N	3		3	
O	0°	10°	0°	10°

<b>DOCUMENT NO.</b> Z8B00180553
<b>SCALE</b> 0 2.5 5mm
<b>EUROPEAN PROJECTION</b> 
<b>ISSUE DATE</b> 24-02-2016
<b>REVISION</b> 01

Figure 1 Outline PG-SOT223, dimensions in mm/inches

## 7 Appendix A

### Table 11 Related Links

- IFX CoolMOS Webpage: [www.infineon.com](http://www.infineon.com)
- IFX Design tools: [www.infineon.com](http://www.infineon.com)

## Revision History

IPN50R800CE

**Revision: 2016-06-13, Rev. 2.1**

Previous Revision

Revision	Date	Subjects (major changes since last revision)
2.0	2016-04-29	Release of final version
2.1	2016-06-13	Updated ID ratings

### Trademarks of Infineon Technologies AG

AURIX™, C166™, CanPAK™, CIPOS™, CoolGaN™, CoolMOS™, CoolSET™, CoolSiC™, CORECONTROL™, CROSSAVE™, DAVE™, DI-POL™, DrBlade™, EasyPIM™, EconoBRIDGE™, EconoDUAL™, EconoPACK™, EconoPIM™, EiceDRIVER™, eupec™, FCOS™, HITFET™, HybridPACK™, Infineon™, ISOFACE™, IsoPACK™, i-Wafer™, MIPAQ™, ModSTACK™, my-d™, NovalithIC™, OmniTune™, OPTIGA™, OptiMOS™, ORIGA™, POWERCODE™, PRIMARION™, PrimePACK™, PrimeSTACK™, PROFET™, PRO-SIL™, RASIC™, REAL3™, ReverSave™, SatRIC™, SIEGET™, SiPMOS™, SmartLEWIS™, SOLID FLASH™, SPOC™, TEMPFET™, thinQ!™, TRENCHSTOP™, TriCore™.

Trademarks updated August 2015

### Other Trademarks

All referenced product or service names and trademarks are the property of their respective owners.

### We Listen to Your Comments

Any information within this document that you feel is wrong, unclear or missing at all? Your feedback will help us to continuously improve the quality of this document. Please send your proposal (including a reference to this document) to:

[erratum@infineon.com](mailto:erratum@infineon.com)

**Published by**  
**Infineon Technologies AG**  
**81726 München, Germany**  
**© 2016 Infineon Technologies AG**  
**All Rights Reserved.**

### Legal Disclaimer

The information given in this document shall in no event be regarded as a guarantee of conditions or characteristics. With respect to any examples or hints given herein, any typical values stated herein and/or any information regarding the application of the device, Infineon Technologies hereby disclaims any and all warranties and liabilities of any kind, including without limitation, warranties of non-infringement of intellectual property rights of any third party.

### Information

For further information on technology, delivery terms and conditions and prices please contact your nearest Infineon Technologies Office ([www.infineon.com](http://www.infineon.com)).

### Warnings

Due to technical requirements, components may contain dangerous substances. For information on the types in question, please contact the nearest Infineon Technologies Office.

The Infineon Technologies component described in this Data Sheet may be used in life-support devices or systems and/or automotive, aviation and aerospace applications or systems only with the express written approval of Infineon Technologies, if a failure of such components can reasonably be expected to cause the failure of that life-support, automotive, aviation and aerospace device or system or to affect the safety or effectiveness of that device or system. Life support devices or systems are intended to be implanted in the human body or to support and/or maintain and sustain and/or protect human life. If they fail, it is reasonable to assume that the health of the user or other persons may be endangered.

# Mouser Electronics

Authorized Distributor

Click to View Pricing, Inventory, Delivery & Lifecycle Information:

[Infineon:](#)

[IPN50R800CEATMA1](#)