

MOSFET

500V CoolMOS™ CE Power Transistor

CoolMOS™ is a revolutionary technology for high voltage power MOSFETs, designed according to the superjunction (SJ) principle and pioneered by Infineon Technologies. CoolMOS™ CE is a price-performance optimized platform enabling to target cost sensitive applications in Consumer and Lighting markets by still meeting highest efficiency standards. The new series provides all benefits of a fast switching Superjunction MOSFET while not sacrificing ease of use and offering the best cost down performance ratio available on the market.

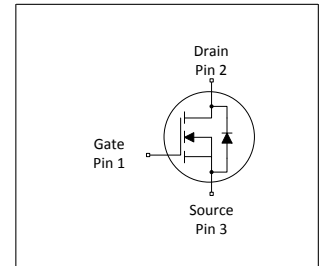

Features

- Extremely low losses due to very low FOM $R_{DS(on)} \cdot Q_g$ and E_{oss}
- Very high commutation ruggedness
- Easy to use/drive
- Pb-free plating, Halogen free mold compound
- Qualified for standard grade applications

Applications

PFC stages, hard switching PWM stages and resonant switching stages for e.g. PC Silverbox, Adapter, LCD & PDP TV and indoor lighting.

Please note: For MOSFET paralleling the use of ferrite beads on the gate or separate totem poles is generally recommended



Table 1 Key Performance Parameters

| Parameter | Value | Unit |
|----------------------|-------|----------|
| $V_{DS} @ T_{j,max}$ | 550 | V |
| $R_{DS(on),max}$ | 1.4 | Ω |
| I_D | 4.8 | A |
| $Q_{g,typ}$ | 8.2 | nC |
| $I_{D,pulse}$ | 8.8 | A |
| $E_{oss}@400V$ | 0.79 | μJ |

| Type / Ordering Code | Package | Marking | Related Links |
|----------------------|-----------|----------|----------------|
| IPD50R1K4CE | PG-TO 252 | 50S1K4CE | see Appendix A |
| IPU50R1K4CE | PG-TO 251 | | |

Table of Contents

| | |
|---|----|
| Description | 1 |
| Maximum ratings | 3 |
| Thermal characteristics | 3 |
| Electrical characteristics | 4 |
| Electrical characteristics diagrams | 6 |
| Test Circuits | 10 |
| Package Outlines | 11 |
| Appendix A | 13 |
| Revision History | 14 |
| Trademarks | 14 |
| Disclaimer | 14 |

500V CoolMOS™ CE Power Transistor

IPD50R1K4CE, IPU50R1K4CE

1 Maximum ratings

at $T_j = 25^\circ\text{C}$, unless otherwise specified

Table 2 Maximum ratings

| Parameter | Symbol | Values | | | Unit | Note / Test Condition |
|---|----------------|------------|------|------------|------------------|--|
| | | Min. | Typ. | Max. | | |
| Continuous drain current ¹⁾ | I_D | - | - | 4.8 3.1 | A | $T_C = 25^\circ\text{C}$ $T_C = 100^\circ\text{C}$ |
| Pulsed drain current ²⁾ | $I_{D,pulse}$ | - | - | 8.8 | A | $T_C = 25^\circ\text{C}$ |
| Avalanche energy, single pulse | E_{AS} | - | - | 49 | mJ | $I_D = 1.1\text{A}$; $V_{DD} = 50\text{V}$ |
| Avalanche energy, repetitive | E_{AR} | - | - | 0.07 | mJ | $I_D = 1.1\text{A}$; $V_{DD} = 50\text{V}$ |
| Avalanche current, repetitive | I_{AR} | - | - | 1.1 | A | - |
| MOSFET dv/dt ruggedness | dv/dt | - | - | 50 | V/ns | $V_{DS} = 0 \dots 400\text{V}$ |
| Gate source voltage | V_{GS} | -20 -30 | - | 20 30 | V | static; AC ($f > 1\text{ Hz}$) |
| Power dissipation (non FullPAK) TO-252, TO-251 | P_{tot} | - | - | 42 | W | $T_C = 25^\circ\text{C}$ |
| Operating and storage temperature | T_j, T_{stg} | -55 | - | 150 | $^\circ\text{C}$ | - |
| Continuous diode forward current | I_S | - | - | 3.4 | A | $T_C = 25^\circ\text{C}$ |
| Diode pulse current ²⁾ | $I_{S,pulse}$ | - | - | 8.8 | A | $T_C = 25^\circ\text{C}$ |
| Reverse diode dv/dt ³⁾ | dv/dt | - | - | 15 | V/ns | $V_{DS} = 0 \dots 400\text{V}$, $I_{SD} \leq I_S$, $T_j = 25^\circ\text{C}$, $t_{cond} < 2\mu\text{s}$ |
| Maximum diode commutation speed ³⁾ | di/dt | - | - | 500 | A/ μs | $V_{DS} = 0 \dots 400\text{V}$, $I_{SD} \leq I_S$, $T_j = 25^\circ\text{C}$, $t_{cond} < 2\mu\text{s}$ |

2 Thermal characteristics

Table 3 Thermal characteristics DPAK, IPAK

| Parameter | Symbol | Values | | | Unit | Note / Test Condition |
|---|------------|--------|------|----------|--------------------|--|
| | | Min. | Typ. | Max. | | |
| Thermal resistance, junction - case | R_{thJC} | - | - | 2.95 | $^\circ\text{C/W}$ | - |
| Thermal resistance, junction - ambient ⁴⁾ | R_{thJA} | - | - | 62 35 | $^\circ\text{C/W}$ | SMD version, device on PCB, minimal footprint SMD version, device on PCB, 6cm ² cooling area ⁴⁾ |
| Soldering temperature, wave- & reflowsoldering allowed | T_{sold} | - | - | 260 | $^\circ\text{C}$ | reflow MSL 1 |

¹⁾ Limited by $T_{j,max}$. Maximum duty cycle $D=0.5$

²⁾ Pulse width t_p limited by $T_{j,max}$

³⁾ $V_{DClink}=400\text{V}$; $V_{DS,peak} < V_{(BR)DSS}$; identical low side and high side switch with identical R_G

⁴⁾ Device on 40mm*40mm*1.5mm one layer epoxy PCB FR4 with 6cm² copper area (thickness 70 μm) for drain connection. PCB is vertical without air stream cooling.

3 Electrical characteristics

Table 4 Static characteristics

| Parameter | Symbol | Values | | | Unit | Note / Test Condition |
|----------------------------------|---------------|--------|------|------|----------|---|
| | | Min. | Typ. | Max. | | |
| Drain-source breakdown voltage | $V_{(BR)DSS}$ | 500 | - | - | V | $V_{GS}=0V, I_D=1mA$ |
| Gate threshold voltage | $V_{(GS)th}$ | 2.50 | 3 | 3.50 | V | $V_{DS}=V_{GS}, I_D=0.07mA$ |
| Zero gate voltage drain current | I_{DSS} | - | - | 1 | μA | $V_{DS}=500V, V_{GS}=0V, T_j=25^\circ C$ $V_{DS}=500V, V_{GS}=0V, T_j=150^\circ C$ |
| Gate-source leakage current | I_{GSS} | - | - | 100 | nA | $V_{GS}=20V, V_{DS}=0V$ |
| Drain-source on-state resistance | $R_{DS(on)}$ | - | 1.26 | 1.40 | Ω | $V_{GS}=13V, I_D=0.9A, T_j=25^\circ C$ $V_{GS}=13V, I_D=0.9A, T_j=150^\circ C$ |
| Gate resistance | R_G | - | 7 | - | Ω | $f=1\text{ MHz, open drain}$ |

Table 5 Dynamic characteristics

| Parameter | Symbol | Values | | | Unit | Note / Test Condition |
|--|--------------|--------|------|------|------|---|
| | | Min. | Typ. | Max. | | |
| Input capacitance | C_{iss} | - | 178 | - | pF | $V_{GS}=0V, V_{DS}=100V, f=1MHz$ |
| Output capacitance | C_{oss} | - | 11 | - | pF | $V_{GS}=0V, V_{DS}=100V, f=1MHz$ |
| Effective output capacitance, energy related ¹⁾ | $C_{o(er)}$ | - | 10 | - | pF | $V_{GS}=0V, V_{DS}=0...400V$ |
| Effective output capacitance, time related ²⁾ | $C_{o(tr)}$ | - | 36 | - | pF | $I_D=constant, V_{GS}=0V, V_{DS}=0...400V$ |
| Turn-on delay time | $t_{d(on)}$ | - | 6.5 | - | ns | $V_{DD}=400V, V_{GS}=13V, I_D=1.1A,$ $R_G=5.3\Omega$ |
| Rise time | t_r | - | 6 | - | ns | $V_{DD}=400V, V_{GS}=13V, I_D=1.1A,$ $R_G=5.3\Omega$ |
| Turn-off delay time | $t_{d(off)}$ | - | 23 | - | ns | $V_{DD}=400V, V_{GS}=13V, I_D=1.1A,$ $R_G=5.3\Omega$ |
| Fall time | t_f | - | 30 | - | ns | $V_{DD}=400V, V_{GS}=13V, I_D=1.1A,$ $R_G=5.3\Omega$ |

Table 6 Gate charge characteristics

| Parameter | Symbol | Values | | | Unit | Note / Test Condition |
|-----------------------|---------------|--------|------|------|------|---|
| | | Min. | Typ. | Max. | | |
| Gate to source charge | Q_{gs} | - | 1 | - | nC | $V_{DD}=400V, I_D=1.1A, V_{GS}=0\text{ to }10V$ |
| Gate to drain charge | Q_{gd} | - | 4.6 | - | nC | $V_{DD}=400V, I_D=1.1A, V_{GS}=0\text{ to }10V$ |
| Gate charge total | Q_g | - | 8.2 | - | nC | $V_{DD}=400V, I_D=1.1A, V_{GS}=0\text{ to }10V$ |
| Gate plateau voltage | $V_{plateau}$ | - | 5.4 | - | V | $V_{DD}=400V, I_D=1.1A, V_{GS}=0\text{ to }10V$ |

¹⁾ $C_{o(er)}$ is a fixed capacitance that gives the same stored energy as C_{oss} while V_{DS} is rising from 0 to 80% $V_{(BR)DSS}$

²⁾ $C_{o(tr)}$ is a fixed capacitance that gives the same charging time as C_{oss} while V_{DS} is rising from 0 to 80% $V_{(BR)DSS}$

Table 7 Reverse diode characteristics

| Parameter | Symbol | Values | | | Unit | Note / Test Condition |
|-------------------------------|-----------|--------|------|------|---------|--|
| | | Min. | Typ. | Max. | | |
| Diode forward voltage | V_{SD} | - | 0.83 | - | V | $V_{GS}=0V, I_F=1.1A, T_i=25^{\circ}C$ |
| Reverse recovery time | t_{rr} | - | 120 | - | ns | $V_R=400V, I_F=1.1A, di_F/dt=100A/\mu s$ |
| Reverse recovery charge | Q_{rr} | - | 0.5 | - | μC | $V_R=400V, I_F=1.1A, di_F/dt=100A/\mu s$ |
| Peak reverse recovery current | I_{rrm} | - | 6.8 | - | A | $V_R=400V, I_F=1.1A, di_F/dt=100A/\mu s$ |

4 Electrical characteristics diagrams

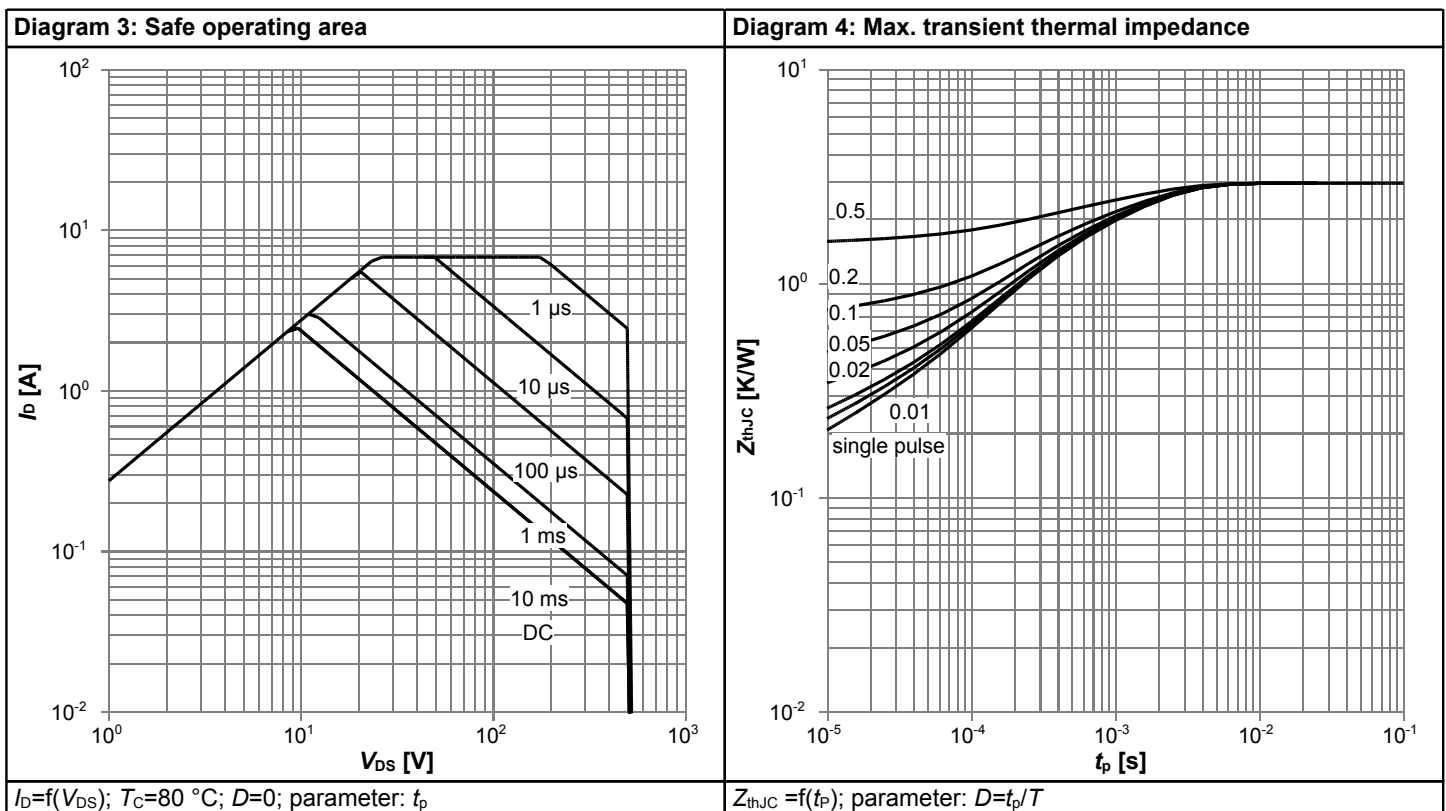
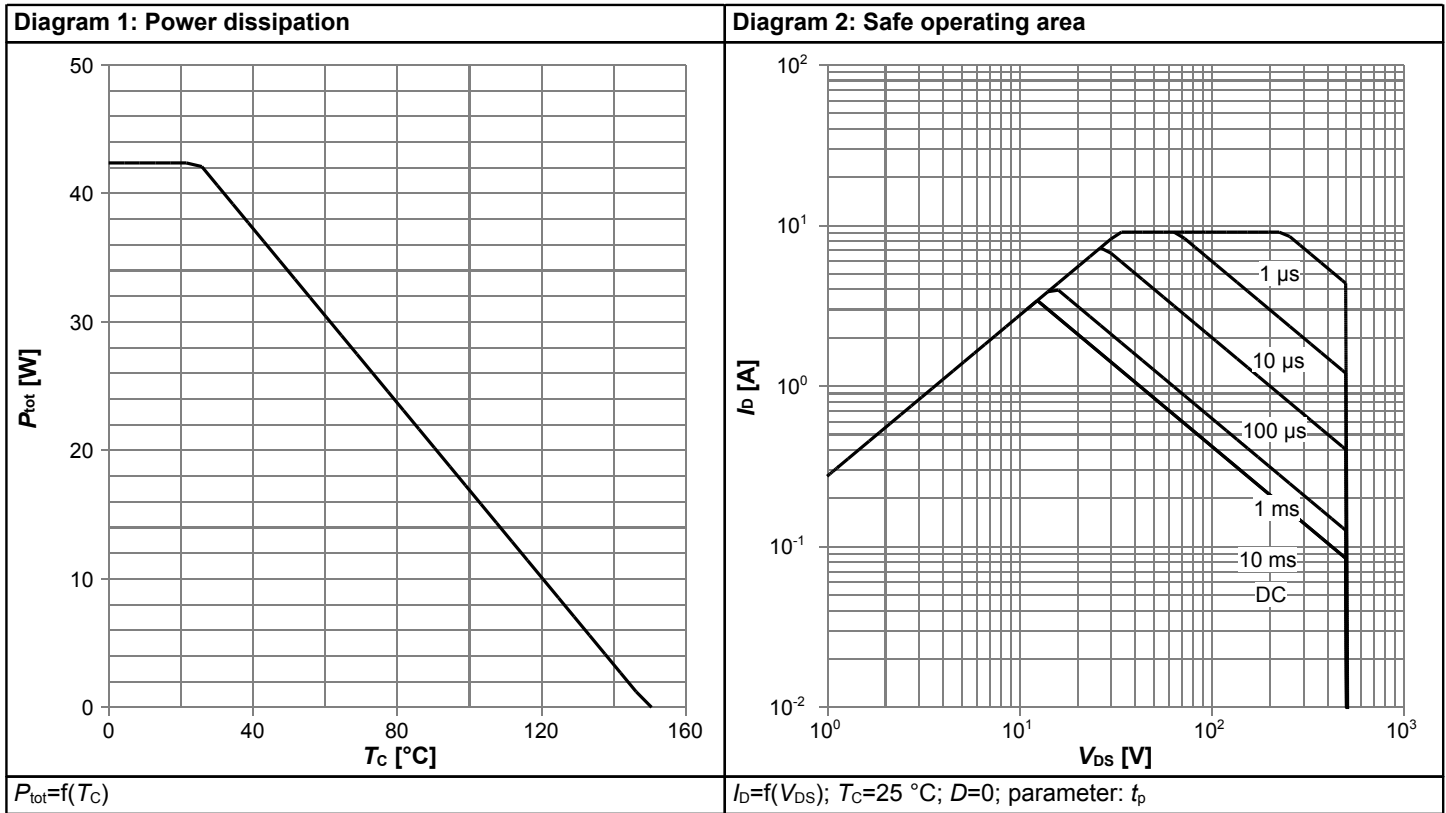

500V CoolMOS™ CE Power Transistor
IPD50R1K4CE, IPU50R1K4CE

Diagram 5: Typ. output characteristics $T_j=25^\circ\text{C}$

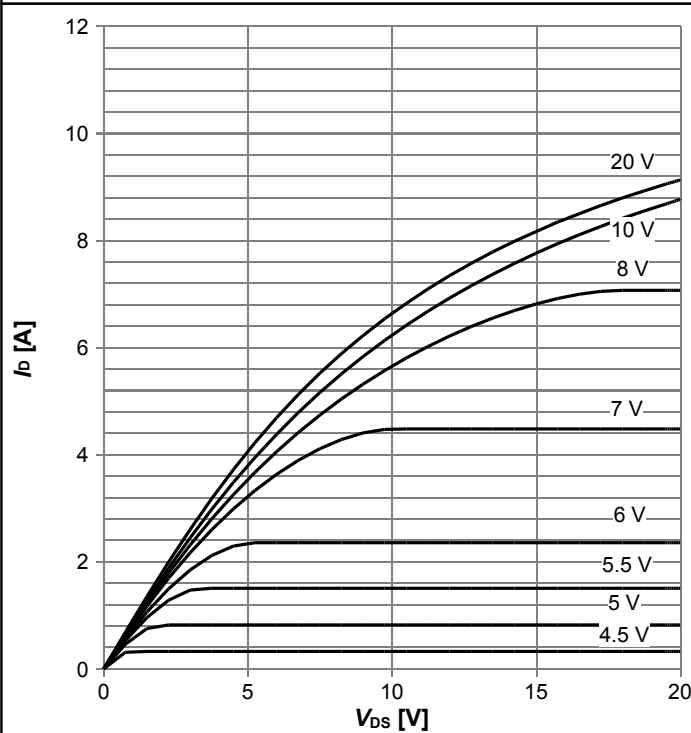

$I_D=f(V_{DS}); T_j=25^\circ\text{C};$ parameter: V_{GS}

Diagram 6: Typ. output characteristics $T_j=125^\circ\text{C}$

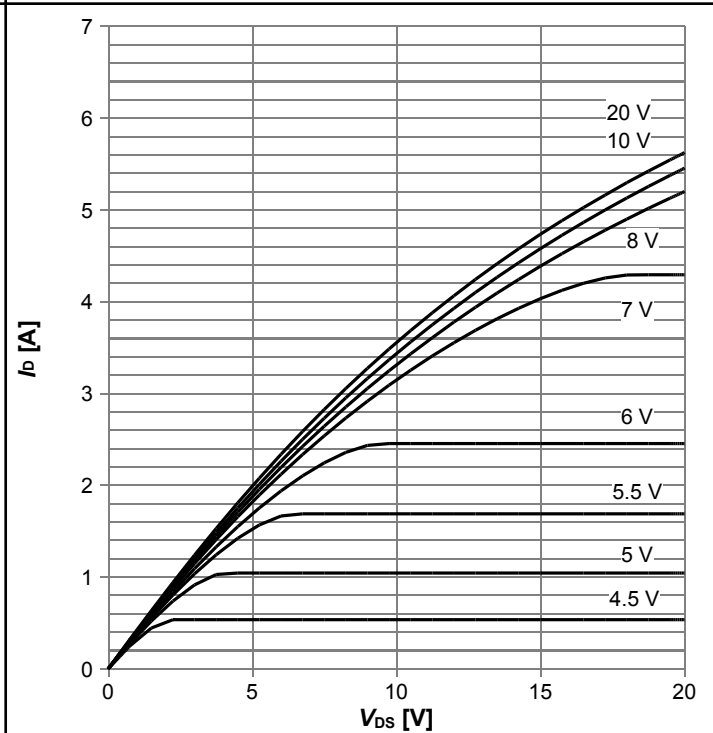

$I_D=f(V_{DS}); T_j=125^\circ\text{C};$ parameter: V_{GS}

Diagram 7: Typ. drain-source on-state resistance

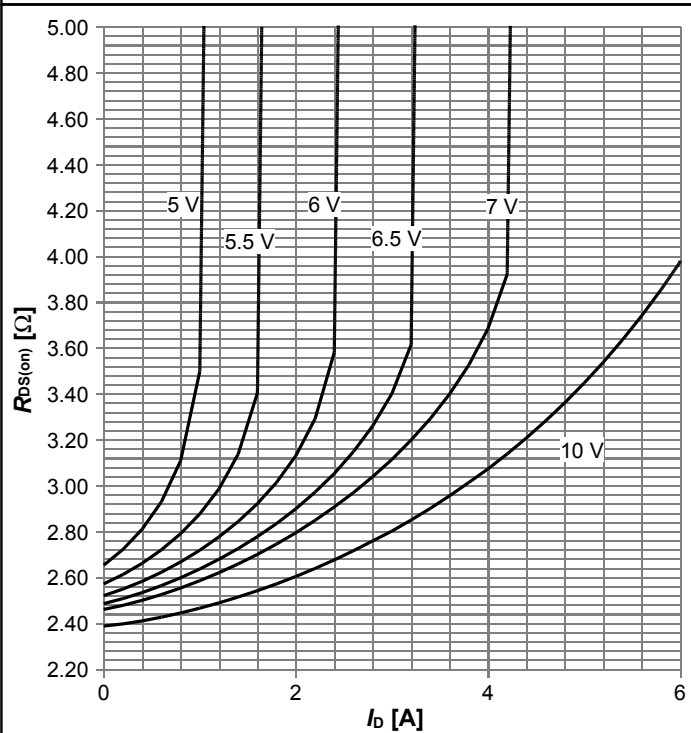

$R_{DS(on)}=f(I_D); T_j=125^\circ\text{C};$ parameter: V_{GS}

Diagram 8: Drain-source on-state resistance

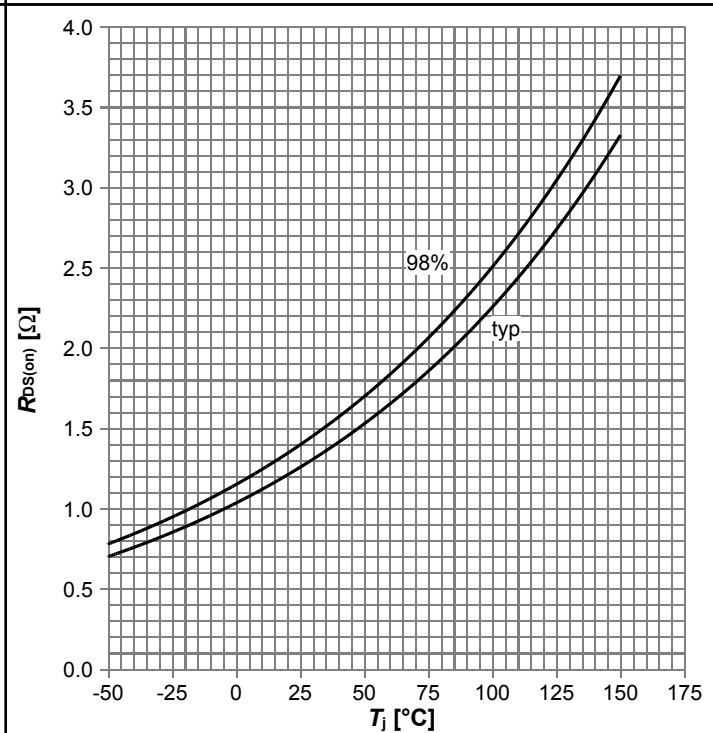

$R_{DS(on)}=f(T_j); I_D=0.9\text{ A}; V_{GS}=13\text{ V}$

500V CoolMOS™ CE Power Transistor
IPD50R1K4CE, IPU50R1K4CE

Diagram 9: Typ. transfer characteristics

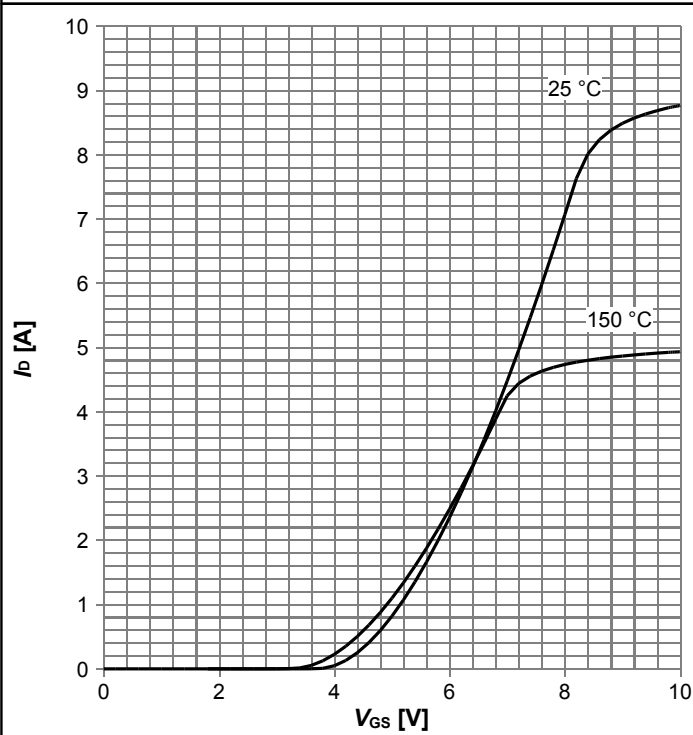

$I_D = f(V_{GS}); V_{DS} = 20V; \text{parameter: } T_j$

Diagram 10: Typ. gate charge

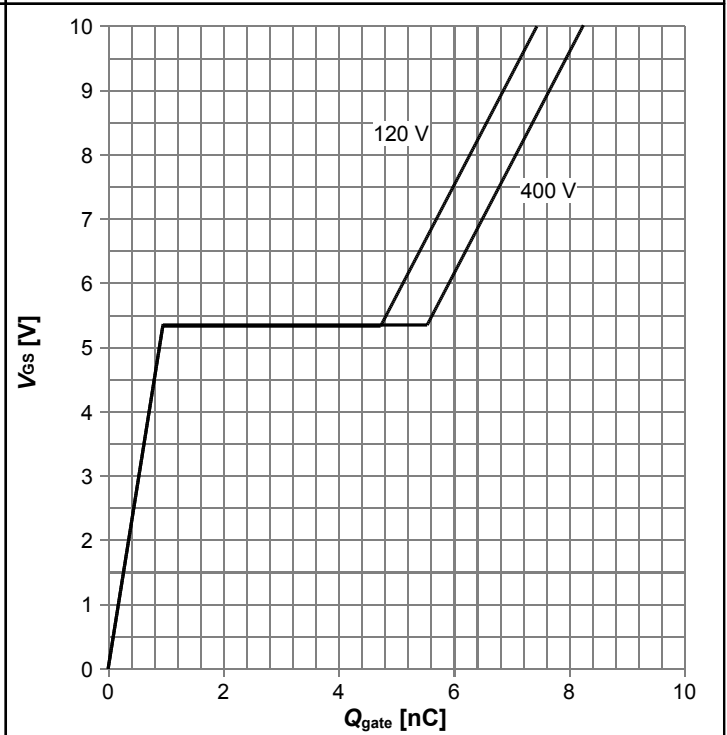

$V_{GS} = f(Q_{gate}); I_D = 1.1 \text{ A pulsed}; \text{parameter: } V_{DD}$

Diagram 11: Avalanche energy

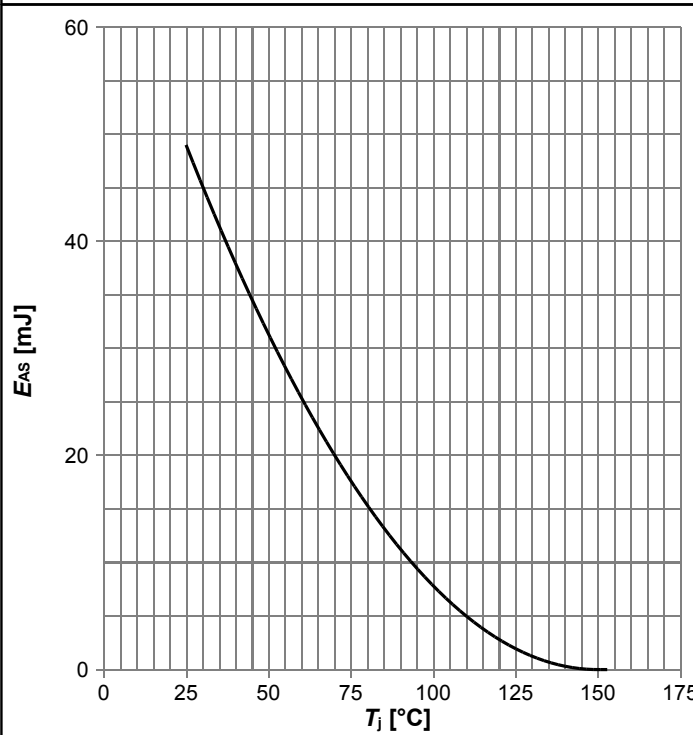

$E_{AS} = f(T_j); I_D = 1.1 \text{ A}; V_{DD} = 50 \text{ V}$

Diagram 12: Drain-source breakdown voltage

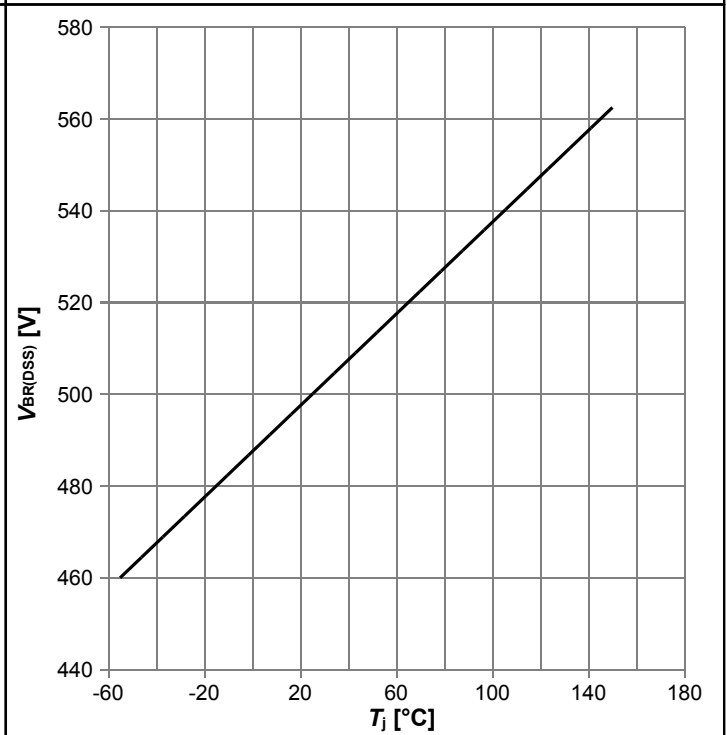

$V_{BR(DSS)} = f(T_j); I_D = 1 \text{ mA}$

500V CoolMOS™ CE Power Transistor
IPD50R1K4CE, IPU50R1K4CE

Diagram 13: Typ. capacitances

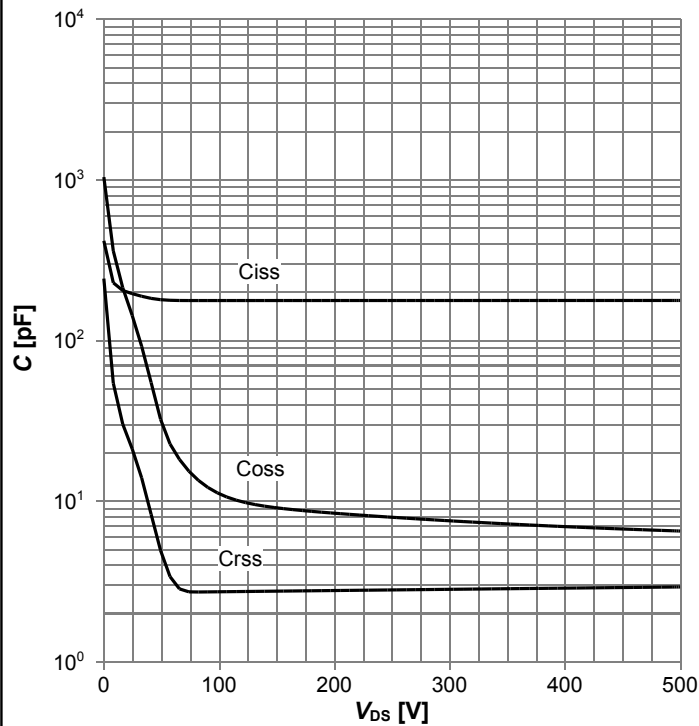

$C=f(V_{Ds}); V_{GS}=0\text{ V}; f=1\text{ MHz}$

Diagram 14: Typ. Coss stored energy

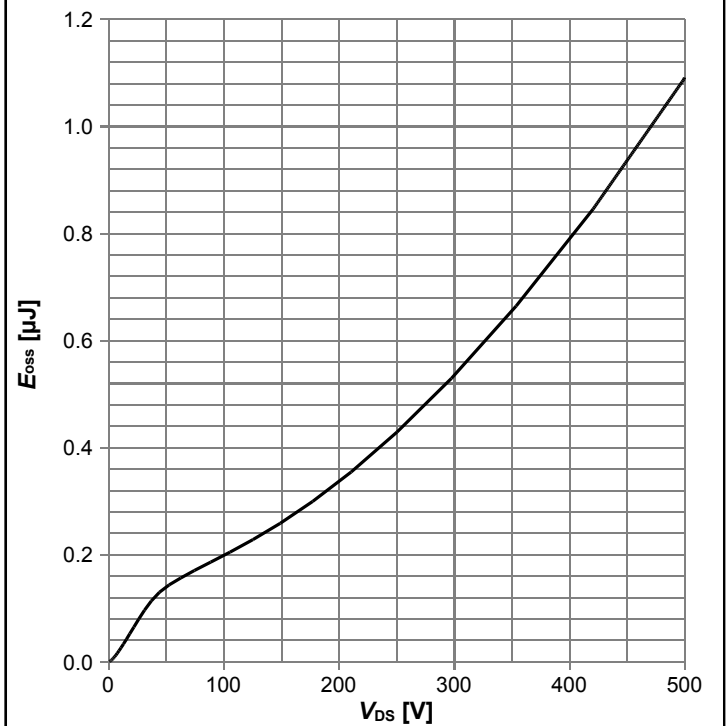

$E_{oss}=f(V_{Ds})$

Diagram 15: Forward characteristics of reverse diode

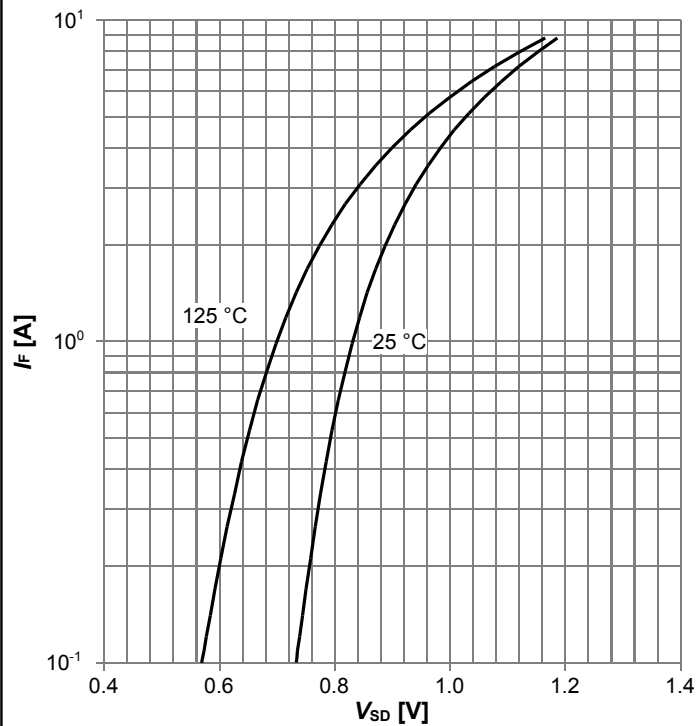

$I_F=f(V_{SD}); \text{parameter: } T_j$

5 Test Circuits

Table 8 Diode characteristics

| Test circuit for diode characteristics | Diode recovery waveform |
|--|-------------------------|
| | |

Table 9 Switching times

| Switching times test circuit for inductive load | Switching times waveform |
|---|--------------------------|
| | |

Table 10 Unclamped inductive load

| Unclamped inductive load test circuit | Unclamped inductive waveform |
|---------------------------------------|------------------------------|
| | |

6 Package Outlines



*) mold flash not included

| DIM | MILLIMETERS | | INCHES | |
|-----|-------------|-------|-------------|-------|
| | MIN | MAX | MIN | MAX |
| A | 2.16 | 2.41 | 0.085 | 0.095 |
| A1 | 0.00 | 0.15 | 0.000 | 0.006 |
| b | 0.64 | 0.89 | 0.025 | 0.035 |
| b2 | 0.65 | 1.15 | 0.026 | 0.045 |
| b3 | 5.00 | 5.50 | 0.197 | 0.217 |
| c | 0.46 | 0.60 | 0.018 | 0.024 |
| c2 | 0.46 | 0.98 | 0.018 | 0.039 |
| D | 5.97 | 6.22 | 0.235 | 0.245 |
| D1 | 5.02 | 5.84 | 0.198 | 0.230 |
| E | 6.40 | 6.73 | 0.252 | 0.265 |
| E1 | 4.70 | 5.60 | 0.185 | 0.220 |
| e | 2.29 (BSC) | | 0.090 (BSC) | |
| e1 | 4.57 (BSC) | | 0.180 (BSC) | |
| N | 3 | | 3 | |
| H | 9.40 | 10.48 | 0.370 | 0.413 |
| L | 1.18 | 1.70 | 0.046 | 0.067 |
| L3 | 0.90 | 1.25 | 0.035 | 0.049 |
| L4 | 0.51 | 1.00 | 0.020 | 0.039 |
| F1 | 10.60 | | 0.417 | |
| F2 | 6.40 | | 0.252 | |
| F3 | 2.20 | | 0.087 | |
| F4 | 5.80 | | 0.228 | |
| F5 | 5.76 | | 0.227 | |
| F6 | 1.20 | | 0.047 | |

| |
|------------------------------------|
| DOCUMENT NO. Z8B00003328 |
| SCALE 0 2.0 4mm |
| EUROPEAN PROJECTION |
| ISSUE DATE 01-09-2015 |
| REVISION 05 |

Figure 1 Outline PG-TO 252, dimensions in mm/inches

500V CoolMOS™ CE Power Transistor
IPD50R1K4CE, IPU50R1K4CE

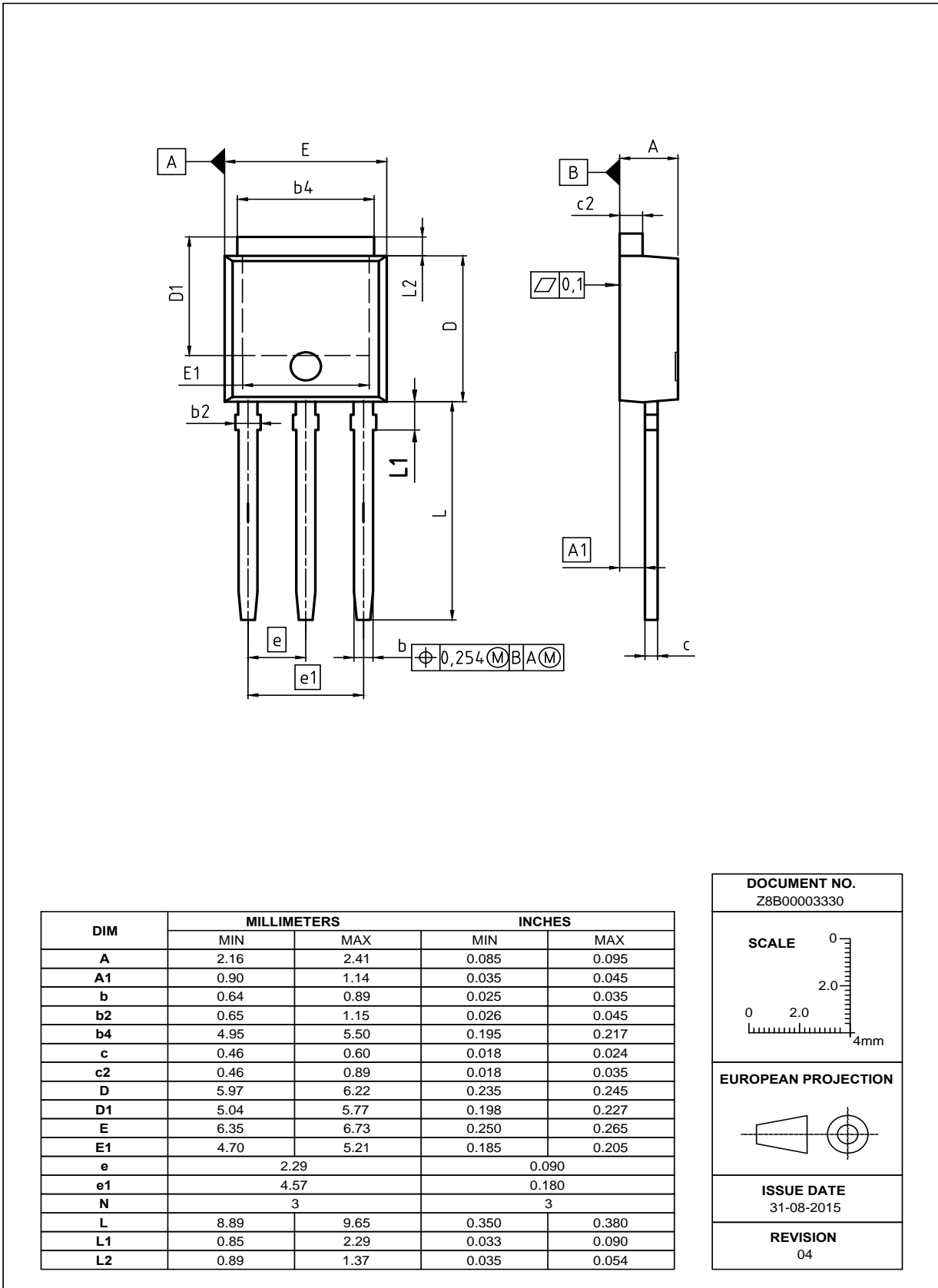

Figure 2 Outline PG-TO 251, dimensions in mm/inches

7 Appendix A

Table 11 Related Links

- IFX CoolMOS Webpage: www.infineon.com
- IFX Design tools: www.infineon.com

500V CoolMOS™ CE Power Transistor

IPD50R1K4CE, IPU50R1K4CE

Revision History

IPD50R1K4CE, IPU50R1K4CE

Revision: 2016-06-13, Rev. 2.4

Previous Revision

| Revision | Date | Subjects (major changes since last revision) |
|----------|------------|---|
| 2.0 | 2012-09-13 | Release of final version |
| 2.1 | 2012-12-05 | release of final datasheet |
| 2.2 | 2013-07-16 | update to Halogen free mold compound |
| 2.3 | 2015-11-17 | Updated to standard grade qualified & updated package drawing |
| 2.4 | 2016-06-13 | Updated ID ratings, Zth, SOA and Pd curves |

Trademarks of Infineon Technologies AG

AURIX™, C166™, CanPAK™, CIPOS™, CoolGaN™, CoolMOS™, CoolSET™, CoolSiC™, CORECONTROL™, CROSSAVE™, DAVE™, DI-POL™, DrBlade™, EasyPIM™, EconoBRIDGE™, EconoDUAL™, EconoPACK™, EconoPIM™, EiceDRIVER™, eupec™, FCOS™, HITFET™, HybridPACK™, Infineon™, ISOFACE™, IsoPACK™, i-Wafer™, MIPAQ™, ModSTACK™, my-d™, NovalithiC™, OmniTune™, OPTIGA™, OptiMOS™, ORIGA™, POWERCODE™, PRIMARION™, PrimePACK™, PrimeSTACK™, PROFET™, PRO-SIL™, RASIC™, REAL3™, ReverSave™, SatRIC™, SIEGET™, SIPMOS™, SmartLEWIS™, SOLID FLASH™, SPOC™, TEMPFET™, thinQ!™, TRENCHSTOP™, TriCore™.

Trademarks updated August 2015

Other Trademarks

All referenced product or service names and trademarks are the property of their respective owners.

We Listen to Your Comments

Any information within this document that you feel is wrong, unclear or missing at all? Your feedback will help us to continuously improve the quality of this document. Please send your proposal (including a reference to this document) to: erratum@infineon.com

Published by
Infineon Technologies AG
81726 München, Germany
© 2016 Infineon Technologies AG
All Rights Reserved.

Legal Disclaimer

The information given in this document shall in no event be regarded as a guarantee of conditions or characteristics. With respect to any examples or hints given herein, any typical values stated herein and/or any information regarding the application of the device, Infineon Technologies hereby disclaims any and all warranties and liabilities of any kind, including without limitation, warranties of non-infringement of intellectual property rights of any third party.

Information

For further information on technology, delivery terms and conditions and prices please contact your nearest Infineon Technologies Office (www.infineon.com).

Warnings

Due to technical requirements, components may contain dangerous substances. For information on the types in question, please contact the nearest Infineon Technologies Office.

The Infineon Technologies component described in this Data Sheet may be used in life-support devices or systems and/or automotive, aviation and aerospace applications or systems only with the express written approval of Infineon Technologies, if a failure of such components can reasonably be expected to cause the failure of that life-support, automotive, aviation and aerospace device or system or to affect the safety or effectiveness of that device or system. Life support devices or systems are intended to be implanted in the human body or to support and/or maintain and sustain and/or protect human life. If they fail, it is reasonable to assume that the health of the user or other persons may be endangered.

Mouser Electronics

Authorized Distributor

Click to View Pricing, Inventory, Delivery & Lifecycle Information:

[Infineon:](#)

[IPD50R1K4CE](#)