

# ATF-58143

## Low Noise Enhancement Mode Pseudomorphic HEMT in a Surface Mount Plastic Package



### Data Sheet

#### Description

Avago Technologies' ATF-58143 is a high dynamic range, low noise E-PHEMT housed in a 4-lead SC-70 (SOT-343) surface mount plastic package.

The combination of high gain, high linearity and low noise makes the ATF-58143 ideal as low noise amplifier for cellular/PCS/WCDMA base stations, wireless local loop, and other applications that require low noise and high linearity performance in the 450 MHz to 6 GHz frequency range.

#### Surface Mount Package SOT-343

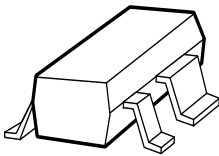

#### Pin Connections and Package Marking

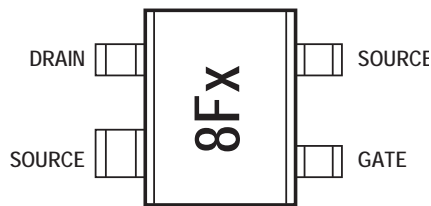

Note:  
Top View. Package marking provides orientation and identification

"8F" = Device Code  
"x" = Date code character  
identifies month of manufacture.

#### Features

- Low noise and high linearity performance
- Enhancement Mode Technology<sup>(1)</sup>
- Excellent uniformity in product specifications
- Low cost surface mount small plastic package SOT-343 (4 lead SC-70) in Tape-and-Reel packaging option available
- Lead-free option available

#### Specifications

2 GHz; 3V, 30 mA (Typ.)

- 30.5 dBm output 3<sup>rd</sup> order intercept
- 19 dBm output power at 1 dB
- 0.5 dB noise figure
- 16.5 dB associated gain

#### Applications

- Q1 LNA for cellular/PCS/WCDMA base stations
- Q1, Q2 LNA and Pre-driver amplifier for 3–4 GHz WLL
- Other low noise and high linearity applications at 450 MHz to 6 GHz

Note:

1. Enhancement mode technology requires positive Vgs, thereby eliminating the need for the negative gate voltage associated with conventional depletion mode devices.



**Attention: Observe precautions for handling electrostatic sensitive devices.**

ESD Machine Model (Class A)  
ESD Human Body Model (Class 1A)  
Refer to Avago Technologies Application Note A004R:  
Electrostatic Discharge Damage and Control.

# ATF-58143 Absolute Maximum Ratings<sup>[1]</sup>

Symbol	Parameter	Units	AbsoluteMaximum
$V_{DS}$	Drain-SourceVoltage <sup>[2]</sup>	V	5
$V_{GS}$	Gate-SourceVoltage <sup>[2]</sup>	V	-5to1
$V_{GD}$	GateDrainVoltage <sup>[2]</sup>	V	-5to1
$I_{DS}$	DrainCurrent <sup>[2]</sup>	mA	100
$P_{diss}$	TotalPowerDissipation <sup>[3]</sup>	mW	500
$P_{inmax}$	RF InputPower (Vds=3V, Ids=30mA)	dBm	+20
	(Vds=0V, Ids=0mA)	dBm	+20
	(Vds=4V, Ids=30mA)	dBm	+20
$I_{GS}$	GateSourceCurrent	mA	2 <sup>[5]</sup>
$T_{CH}$	ChannelTemperature	°C	150
$T_{STG}$	StorageTemperature	°C	-65to150
$\theta_{jc}$	ThermalResistance <sup>[4]</sup>	°C/W	162

Notes:

1. Operation of this device above any one of these parameters may cause permanent damage.
2. Assumes DC quiescent conditions.
3. Source lead temperature is 25°C. Derate 6.2 mW/°C for  $T_L > 33^\circ\text{C}$ .
4. Thermal resistance measured using 150°C Liquid Crystal Measurement method.
5. The device can handle +13 dBm RF Input Power provided  $I_{GS}$  is limited to 2 mA.  $I_{GS}$  at  $P_{1dB}$  drive level is bias circuit dependent. See applications section for additional information.

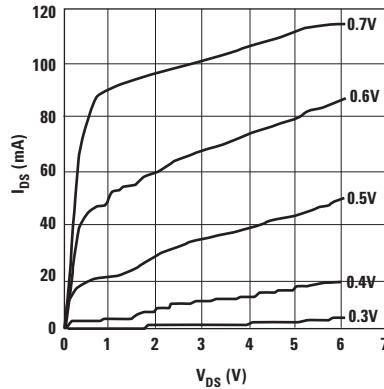

Figure 1. Typical I-V Curves ( $V_{GS}=0.1V$  per step)

## Product Consistency Distribution Charts<sup>[6,7]</sup>

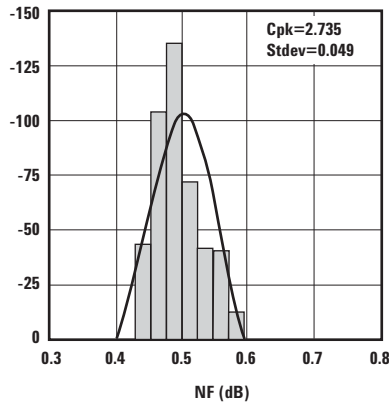

Figure 2. NF @ 3V, 30 mA.  
USL = 0.9, Nominal = 0.5

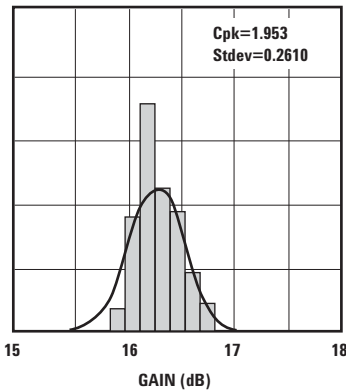

Figure 3. Gain @ 3V, 30 mA.  
USL = 18.5, LSL = 15, Nominal = 16.5

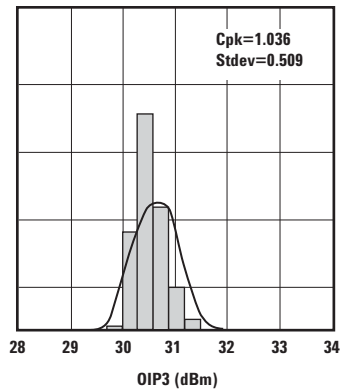

Figure 4. OIP3 @ 3V, 30 mA.  
LSL = 29, Nominal = 30.5

Notes:

6. Distribution data sample size is 500 samples taken from 3 different wafers. Future wafers allocated to this product may have nominal values anywhere between the upper and lower limits.
7. Measurements made on production test board. This circuit represents a trade-off between an optimal noise match and a realizable match based on production test equipment. Circuit losses have been de-embedded from actual measurements.

## ATF-58143 Electrical Specifications

$T_A = 25^\circ\text{C}$ , RF parameters measured in a test circuit for a typical device

Symbol	Parameter and Test Condition	Units	Min.	Typ. <sup>[2]</sup>	Max.		
Vgs	Operational Gate Voltage	Vds = 3V, Ids = 30 mA	V	0.4	0.75		
Vth	Threshold Voltage	Vds = 3V, Ids = 4 mA	V	0.18	0.52		
Idss	Saturated Drain Current	Vds = 3V, Vgs = 0V	$\mu\text{A}$	—	5		
Gm	Transconductance	Vds = 3V, gm = $\Delta\text{Idss}/\Delta\text{Vgs}$ ; $\Delta\text{Vgs} = 0.75 - 0.7 = 0.05\text{V}$	mmho	230	410	560	
Igss	Gate Leakage Current	Vgd = Vgs = -3V	$\mu\text{A}$	—	—	200	
NF	Noise Figure <sup>[1]</sup>	f = 2 GHz	Vds = 3V, Ids = 30 mA	dB	—	0.5	0.9
		f = 900 MHz	Vds = 3V, Ids = 30 mA	dB	—	0.3	—
		f = 2 GHz	Vds = 4V, Ids = 30 mA	dB	—	0.5	—
		f = 900 MHz	Vds = 4V, Ids = 30 mA	dB	—	0.3	—
Ga	Associated Gain <sup>[1]</sup>	f = 2 GHz	Vds = 3V, Ids = 30 mA	dB	15	16.5	18.5
		f = 900 MHz	Vds = 3V, Ids = 30 mA	dB	—	23.1	—
		f = 2 GHz	Vds = 4V, Ids = 30 mA	dB	—	17.7	—
		f = 900 MHz	Vds = 4V, Ids = 30 mA	dB	—	22.5	—
OIP3	Output 3 <sup>rd</sup> Order Intercept Point <sup>[1]</sup>	f = 2 GHz	Vds = 3V, Ids = 30 mA	dBm	29	30.5	—
		f = 900 MHz	Vds = 3V, Ids = 30 mA	dBm	—	28.6	—
		f = 2 GHz	Vds = 4V, Ids = 30 mA	dBm	—	31.5	—
		f = 900 MHz	Vds = 4V, Ids = 30 mA	dBm	—	31.0	—
P1dB	1dB Compressed Output Power <sup>[1]</sup>	f = 2 GHz	Vds = 3V, Ids = 30 mA	dBm	—	19	—
		f = 900 MHz	Vds = 3V, Ids = 30 mA	dBm	—	18	—
		f = 2 GHz	Vds = 4V, Ids = 30 mA	dBm	—	21	—
		f = 900 MHz	Vds = 4V, Ids = 30 mA	dBm	—	19	—

Notes:

1. Measurements obtained using production test board described in Figure 5.
2. Typical values determined from a sample size of 500 parts from 3 wafers.

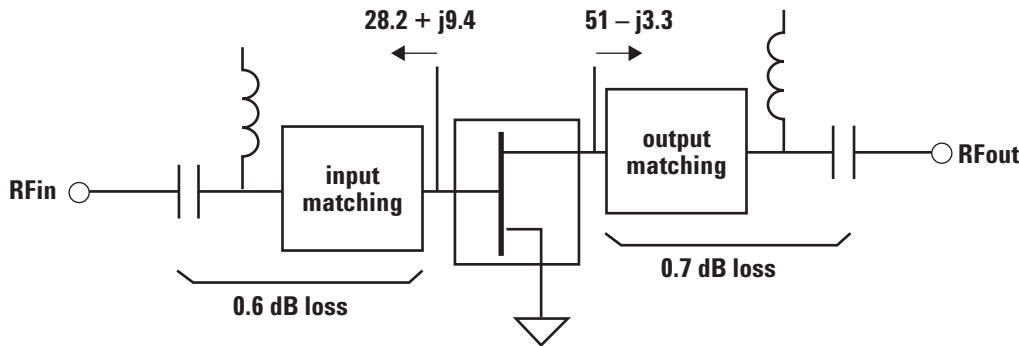
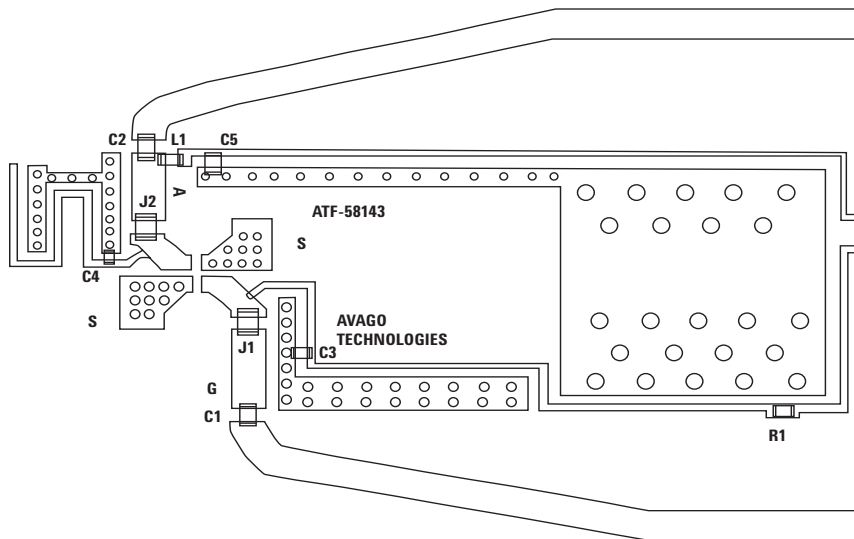

Figure 5. Block diagram of 2 GHz production test board used for Noise Figure, Associated Gain, P1dB and OIP3 measurements. This circuit represents a trade-off between an optimal noise match and associated impedance matching circuit losses.



- C1 : 2.7 pF Cap (0603)
- C2 : 1 pF Cap (0603)
- C3 : 1200 pF Cap (0603)
- C4 : 120 pF Cap (0402)
- C5 : 1200 pF Cap (0603)
- R1 : 49.9 Ohm (0603)
- L1 : 56 nH (0603)
- J1 : 0 Ohm, Jumper (0805)
- J2 : 0 Ohm, Jumper (0805)
- J3 : 0 Ohm, Jumper (0402)
- J4 : 0 Ohm, Jumper (0402)

Figure 6. Close-up of Production Test Board.

### ATF-58143 Typical Performance Curves

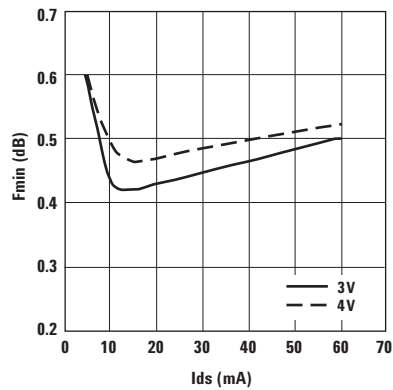

Figure 7. Fmin vs. Ids and Vds Tuned for Max OIP3 and Fmin at 2 GHz.

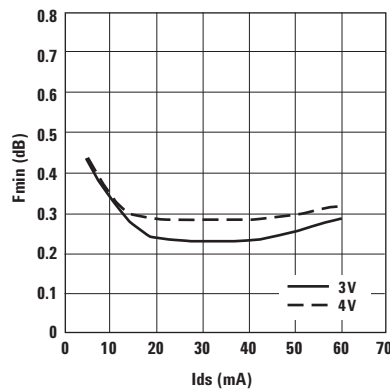

Figure 8. Fmin vs. Ids and Vds Tuned for Max OIP3 and Fmin at 900 MHz.

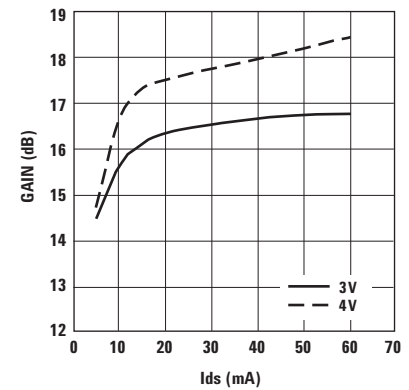

Figure 9. Gain vs. Ids and Vds Tuned for Max OIP3 and Fmin at 2 GHz.

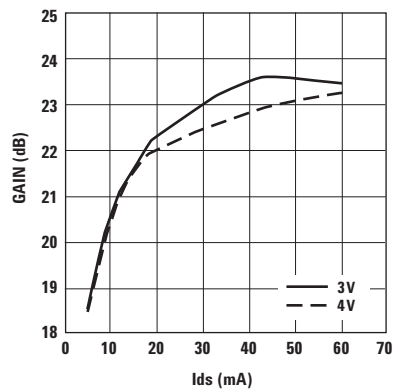

Figure 10. Gain vs. Ids and Vds Tuned for Max OIP3 and Fmin at 900 MHz.

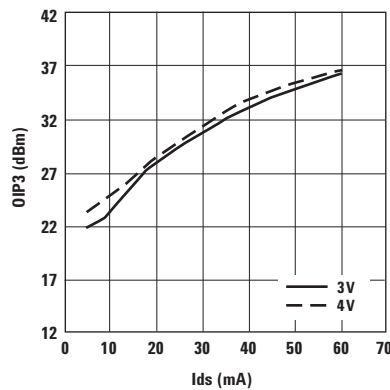

Figure 11. OIP3 vs. Ids and Vds Tuned for Max OIP3 and Fmin at 2 GHz.

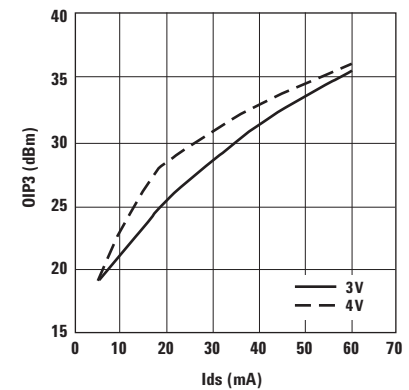

Figure 12. OIP3 vs. Ids and Vds Tuned for Max OIP3 and Fmin at 900 MHz.

## ATF-58143 Typical Performance Curves, continued

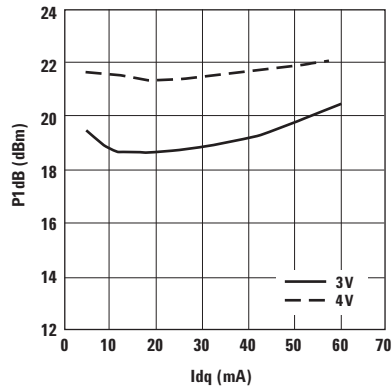

Figure 13. P1dB vs. Idq and Vds Tuned for Max OIP3 and Fmin at 2 GHz.<sup>[1]</sup>

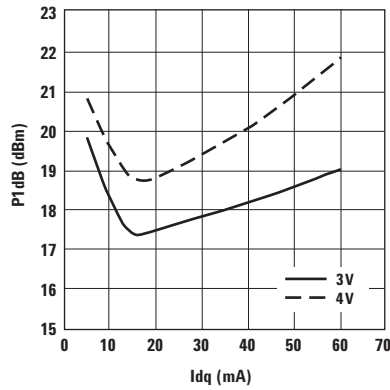

Figure 14. P1dB vs. Idq and Vds Tuned for Max OIP3 and Fmin at 900 MHz.<sup>[1]</sup>

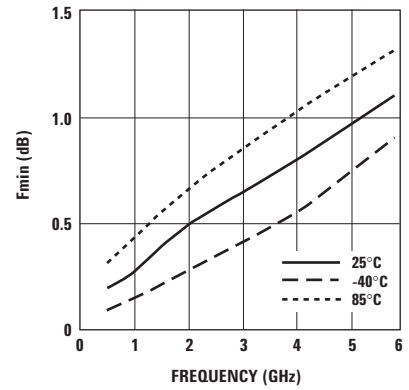

Figure 15. Fmin vs. Frequency and Temp. Tuned for Max OIP3 and Fmin at 3V, 30 mA.

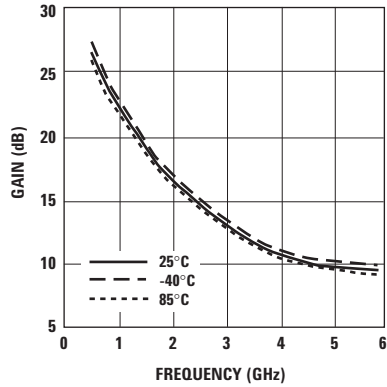

Figure 16. Gain vs. Frequency and Temp. Tuned for Max OIP3 and Fmin at 3V, 30 mA.

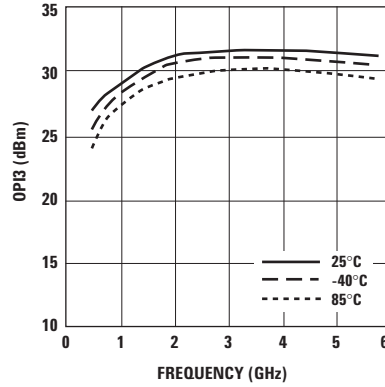

Figure 17. OIP3 vs. Frequency and Temp. Tuned for Max OIP3 and Fmin at 3V, 30 mA.

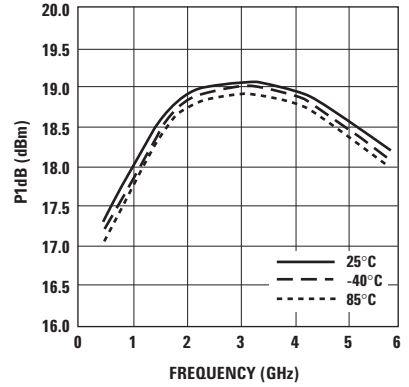

Figure 18. P1dB vs. Frequency and Temp. Tuned for Max OIP3 and Fmin at 3V, 30 mA.

### Note:

1. When plotting P1dB, the drain current was allowed to vary dependent on the RF input power.

**ATF-58143 Typical Scattering Parameters,  $V_{DS} = 3V, I_{DS} = 30\text{ mA}$**

Freq. GHz	$S_{11}$			$S_{21}$			$S_{12}$		$S_{22}$		MSG/MAG dB
	Mag.	Ang.	dB	Mag.	Ang.	dB	Mag.	Ang.	Mag.	Ang.	
0.1	0.98	-17.1	27.29	23.14	168.7	-40.10	0.010	80.8	0.67	-12.1	33.69
0.5	0.81	-92.0	25.25	18.31	123.7	-28.10	0.039	45.7	0.42	-46.6	26.68
0.9	0.75	-126.4	21.87	12.40	103.4	-26.12	0.049	34.8	0.32	-66.7	23.99
1.0	0.73	-132.2	21.18	11.46	99.8	-25.87	0.051	33.4	0.31	-72.3	23.52
1.5	0.69	-153.2	18.38	8.31	85.1	-24.70	0.058	29.4	0.25	-90.8	21.54
1.9	0.66	-165.9	16.74	6.88	75.4	-23.86	0.064	27.4	0.23	-103.6	20.30
2.0	0.65	-169.3	16.40	6.61	73.1	-23.65	0.066	26.9	0.22	-106.0	20.03
2.5	0.63	176.3	14.83	5.51	61.9	-22.71	0.073	24.4	0.19	-118.1	18.77
3.0	0.61	160.7	13.51	4.74	50.9	-21.87	0.081	21.1	0.17	-133.3	17.69
3.5	0.61	147.4	12.35	4.15	40.4	-21.10	0.088	17.7	0.15	-145.4	16.73
4.0	0.62	133.8	11.28	3.66	30.2	-20.45	0.095	13.5	0.13	-155.7	15.86
4.5	0.64	123.7	10.32	3.28	20.5	-19.86	0.102	9.3	0.13	-175.4	15.09
5.0	0.66	112.5	9.41	2.96	11.1	-19.39	0.107	4.9	0.13	166.2	14.40
5.5	0.68	103.7	8.61	2.70	2.1	-18.87	0.114	0.7	0.14	152.8	13.74
6.0	0.69	93.0	7.84	2.47	-7.3	-18.44	0.120	-4.4	0.14	140.7	13.14
7.0	0.71	77.2	6.47	2.11	-24.8	-17.63	0.131	-14.6	0.17	120.7	12.06
8.0	0.74	58.3	5.14	1.81	-43.1	-17.13	0.139	-26.1	0.19	95.4	11.14
9.0	0.78	39.7	3.77	1.54	-60.7	-16.67	0.147	-37.0	0.24	70.1	10.22
10.0	0.84	25.1	2.55	1.34	-78.8	-16.21	0.155	-50.2	0.34	52.4	9.39
11.0	0.87	10.2	1.25	1.16	-97.1	-16.04	0.158	-64.2	0.41	37.3	8.65
12.0	0.89	-3.9	0.19	1.02	-114.0	-15.72	0.164	-78.3	0.46	21.5	7.96
13.0	0.90	-20.0	-1.09	0.88	-132.2	-15.86	0.161	-93.6	0.52	2.5	7.39
14.0	0.93	-31.4	-2.53	0.75	-148.3	-16.22	0.154	-106.5	0.58	-14.1	6.85
15.0	0.96	-43.9	-4.00	0.63	-162.8	-16.73	0.146	-118.2	0.66	-26.0	6.36
16.0	0.94	-54.2	-5.46	0.53	-176.5	-17.15	0.139	-128.6	0.72	-36.3	5.85
17.0	0.96	-65.1	-7.14	0.44	168.6	-17.68	0.131	-142.4	0.74	-49.0	5.27
18.0	0.93	-79.8	-8.81	0.36	153.8	-18.36	0.121	-155.6	0.77	-64.8	4.77

**Typical Noise Parameters,  $V_{DS} = 3V, I_{DS} = 30\text{ mA}$**

Freq GHz	$F_{min}$ dB	$\Gamma_{opt}$ Mag.	$\Gamma_{opt}$ Ang.	$R_{n/50}$	$G_a$ dB
0.5	0.12	0.39	17.775	0.04	25.33
0.9	0.18	0.37	46.9	0.04	22.26
1.0	0.20	0.36	53.525	0.04	21.54
1.5	0.32	0.32	80	0.04	19.16
1.9	0.43	0.30	101	0.04	17.65
2.0	0.45	0.30	107.7	0.04	17.33
2.4	0.51	0.29	125.2	0.04	16.23
3.0	0.58	0.31	154.475	0.05	14.77
3.9	0.75	0.35	-156.95	0.06	13.39
5.0	0.87	0.42	-120.93	0.09	11.92
5.8	1.01	0.50	-100.83	0.15	11.07
6.0	1.04	0.53	-97.15	0.18	10.93

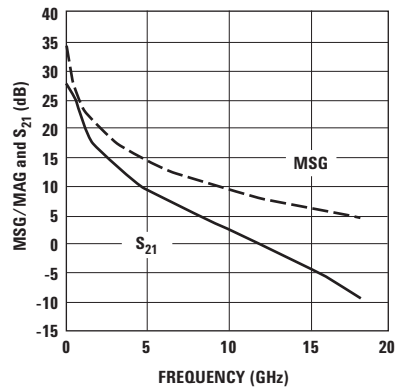

**Figure 19. MSG/MAG and  $S_{21}$  vs. Frequency at 3V, 30 mA.**

Notes:

- $F_{min}$  values at 2 GHz and higher are based on measurements while the  $F_{min}$  below 2 GHz have been extrapolated. The  $F_{min}$  values are based on a set of 16 noise figure measurements made at 16 different impedances using an ATN NP5 test system. From these measurements  $F_{min}$  is calculated. Refer to the noise parameter application section for more information.
- S and noise parameters are measured on a microstrip line made on 0.025 inch thick alumina carrier. The input reference plane is at the end of the gate lead. The output reference plane is at the end of the drain lead. The parameters include the effect of four plated through via holes connecting source landing pads on top of the test carrier to the microstrip ground plane on the bottom side of the carrier. Two 0.020 inch diameter via holes are placed within 0.010 inch from each source lead contact point, one via on each side of that point.

### ATF-58143 Typical Scattering Parameters, $V_{DS} = 4V, I_{DS} = 30\text{ mA}$

Freq. GHz	$S_{11}$			$S_{21}$			$S_{12}$		$S_{22}$		MSG/MAG dB
	Mag.	Ang.	dB	Mag.	Ang.	dB	Mag.	Ang.	Mag.	Ang.	
0.1	0.99	-16.3	28.16	25.6	169.65	-41.08	0.01	81.1	0.65	-10.17	34.62
0.5	0.83	-94.5	25.82	19.5	125.68	-28.95	0.04	46.2	0.45	-54.83	27.39
0.9	0.76	-133.1	22.52	13.4	104.58	-27.00	0.04	33.9	0.33	-76.45	24.76
1	0.75	-139.7	21.83	12.3	100.73	-26.74	0.05	32.0	0.31	-80.28	24.29
1.5	0.72	-162.2	18.94	8.9	85.42	-25.79	0.05	26.9	0.24	-95.17	22.37
1.9	0.71	-172.7	17.18	7.2	75.68	-25.25	0.05	24.8	0.21	-104.27	21.21
2	0.70	-174.9	16.79	6.9	73.47	-25.09	0.06	24.4	0.21	-106.18	20.94
2.5	0.69	173.5	14.67	5.4	59.58	-24.15	0.06	21.7	0.18	-117.35	19.41
3	0.68	161.6	13.05	4.5	46.88	-23.33	0.07	19.0	0.16	-124.85	18.19
4	0.67	141.9	11.00	3.5	28.55	-22.14	0.08	14.1	0.13	-137.33	16.57
5	0.69	123.1	9.29	2.9	10.32	-21.13	0.09	7.3	0.12	-42.65	15.21
6	0.73	108.9	7.73	2.4	-7.48	-20.28	0.10	-1.3	0.13	158.73	14.00
7	0.76	96.3	6.16	2.0	-23.78	-19.80	0.10	-9.7	0.17	125.87	12.98
8	0.79	82.4	4.74	1.7	-39.33	-19.32	0.11	-16.9	0.20	104.88	12.03
9	0.82	71.2	3.63	1.5	-55.93	-18.49	0.12	-26.7	0.25	83.12	11.06
10	0.85	60.1	2.63	1.4	-73.30	-17.74	0.13	-39.3	0.31	61.03	10.19
11	0.87	47.2	1.52	1.2	-90.53	-17.31	0.14	-52.2	0.38	41.33	9.42
12	0.89	36.2	0.38	1.0	-106.67	-17.12	0.14	-64.5	0.44	22.65	8.75
13	0.91	26.6	-0.80	0.9	-121.58	-17.09	0.14	-75.2	0.49	6.28	8.15
14	0.93	17.2	-2.01	0.8	-135.15	-17.15	0.14	-84.2	0.54	-7.48	7.57
15	0.94	9.2	-3.24	0.7	-148.98	-17.22	0.14	-94.3	0.59	-22.78	6.99
16	0.94	1.2	-4.43	0.6	-164.25	-17.36	0.14	-106.1	0.64	-39.22	6.46
17	0.92	-10.5	-5.79	0.5	-59.55	-17.68	0.13	-119.3	0.68	-53.35	5.94
18	0.91	17.6	-6.74	0.5	170.70	-17.94	0.13	-127.5	0.69	-71.73	5.60

### Typical Noise Parameters, $V_{DS} = 4V, I_{DS} = 30\text{ mA}$

Freq GHz	$F_{min}$ dB	$\Gamma_{opt}$ Mag.	$\Gamma_{opt}$ Ang.	$R_{n/50}$	$G_a$ dB
0.5	0.14	0.38	9.7	0.03	24.85
0.9	0.23	0.36	44.4	0.04	22.21
1.0	0.25	0.35	54.0	0.04	21.51
1.5	0.35	0.32	78.7	0.04	19.21
1.9	0.47	0.3	100.7	0.04	17.71
2.0	0.49	0.3	105.4	0.04	17.39
2.4	0.55	0.28	124.0	0.04	16.25
3.0	0.61	0.3	153.9	0.05	14.86
3.9	0.78	0.35	-157.2	0.07	13.51
5.0	0.91	0.42	-120.8	0.1	12.05
5.8	1.05	0.49	-101.2	0.16	11.14
6.0	1.11	0.53	-97.4	0.19	11.14

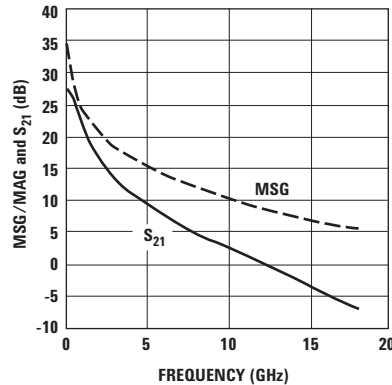

Figure 20. MSG/MAG and  $S_{21}$  vs. Frequency at 4V, 30 mA.

Notes:

- $F_{min}$  values at 2 GHz and higher are based on measurements while the  $F_{min}$  below 2 GHz have been extrapolated. The  $F_{min}$  values are based on a set of 16 noise figure measurements made at 16 different impedances using an ATN NP5 test system. From these measurements  $F_{min}$  is calculated. Refer to the noise parameter application section for more information.
- S and noise parameters are measured on a microstrip line made on a 0.025 inch thick alumina carrier. The input reference plane is at the end of the gate lead. The output reference plane is at the end of the drain lead. The parameters include the effect of four plated through via holes connecting source landing pads on top of the test carrier to the microstrip ground plane on the bottom side of the carrier. Two 0.020 inch diameter via holes are placed within 0.010 inch from each source lead contact point, one via on each side of that point.

## Ordering Information

Part Number	No. of Devices	Container
ATF-58143-TR1G	3000	7" Reel
ATF-58143-TR2G	10000	13" Reel
ATF-58143-BLKG	100	antistatic bag

## Package Dimensions Outline 43 (SOT-343/SC70 4 lead)

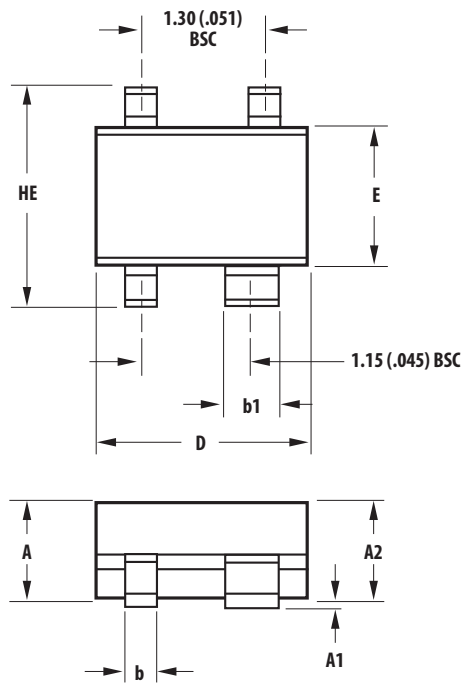

SYMBOL	DIMENSIONS (mm)	
	MIN.	MAX.
E	1.15	1.35
D	1.85	2.25
HE	1.80	2.40
A	0.80	1.10
A2	0.80	1.00
A1	0.00	0.10
b	0.15	0.40
b1	0.55	0.70
c	0.10	0.20
L	0.10	0.46

## Recommended PCB Pad Layout for Avago's SC70 4L/SOT-343 Products

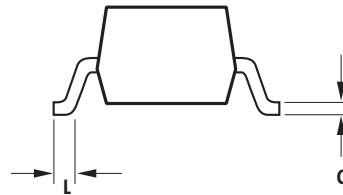
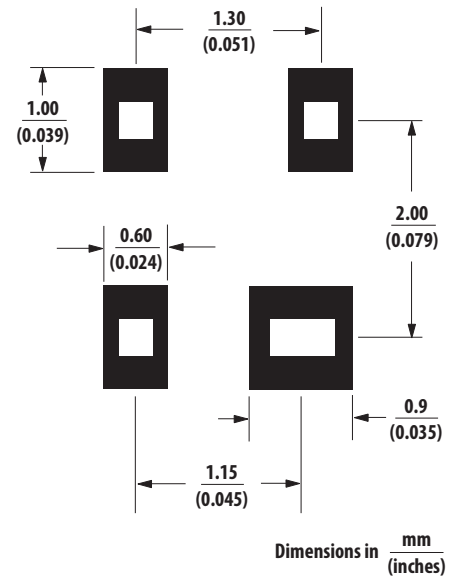

### NOTES:

1. All dimensions are in mm.
2. Dimensions are inclusive of plating.
3. Dimensions are exclusive of mold flash & metal burr.
4. All specifications comply to EIAJ SC70.
5. Die is facing up for mold and facing down for trim/form, ie: reverse trim/form.
6. Package surface to be mirror finish.



## Device Orientation

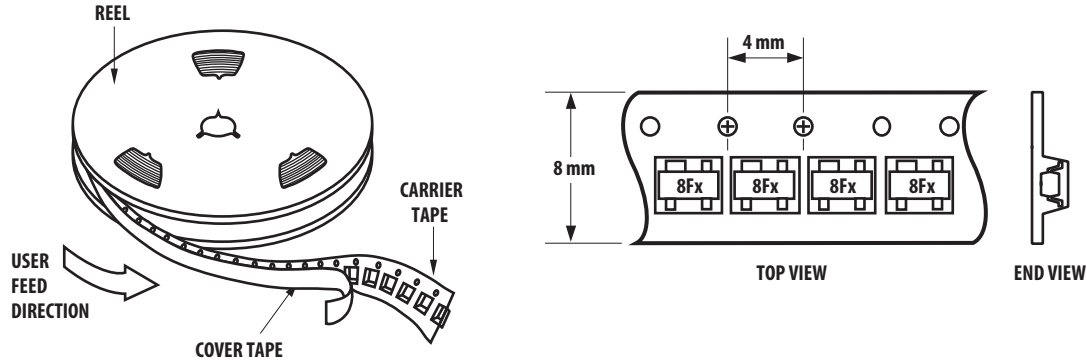

## Tape Dimensions For Outline 4T

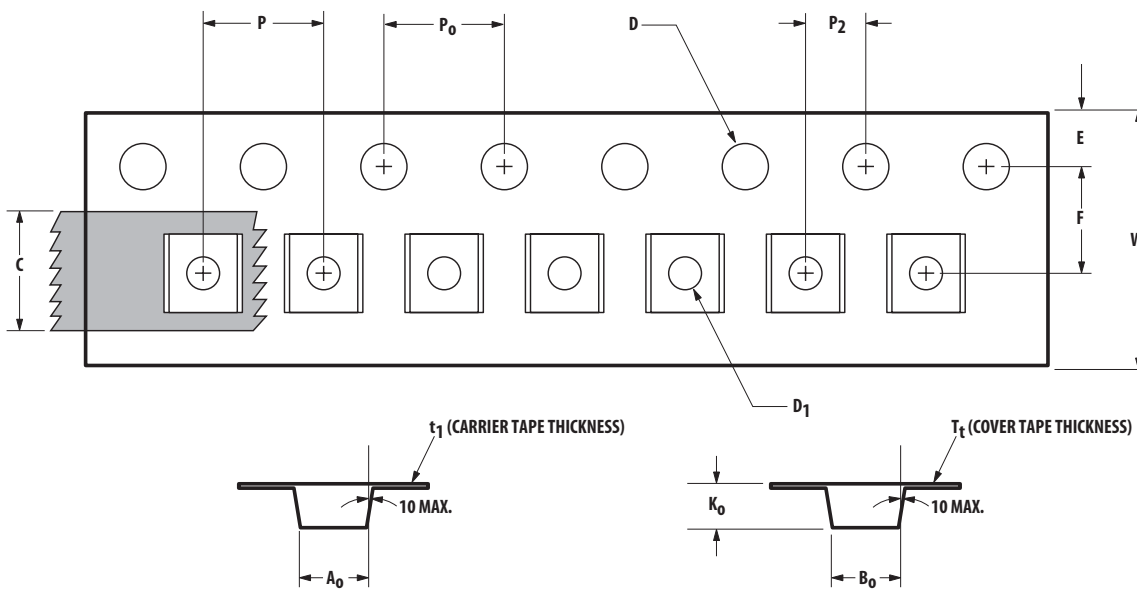

DESCRIPTION		SYMBOL	SIZE (mm)	SIZE (INCHES)
CAVITY	LENGTH	$A_0$	$2.40 \pm 0.10$	$0.094 \pm 0.004$
	WIDTH	$B_0$	$2.40 \pm 0.10$	$0.094 \pm 0.004$
	DEPTH	$K_0$	$1.20 \pm 0.10$	$0.047 \pm 0.004$
	PITCH	$P$	$4.00 \pm 0.10$	$0.157 \pm 0.004$
	BOTTOM HOLE DIAMETER	$D_1$	$1.00 + 0.25$	$0.039 + 0.010$
PERFORATION	DIAMETER	$D$	$1.55 \pm 0.10$	$0.061 + 0.002$
	PITCH	$P_0$	$4.00 \pm 0.10$	$0.157 \pm 0.004$
	POSITION	$E$	$1.75 \pm 0.10$	$0.069 \pm 0.004$
CARRIER TAPE	WIDTH	$W$	$8.00 + 0.30 - 0.10$	$0.315 + 0.012$
	THICKNESS	$t_1$	$0.254 \pm 0.02$	$0.0100 \pm 0.0008$
COVER TAPE	WIDTH	$C$	$5.40 \pm 0.10$	$0.205 + 0.004$
	TAPE THICKNESS	$T_t$	$0.062 \pm 0.001$	$0.0025 \pm 0.0004$
DISTANCE	CAVITY TO PERFORATION (WIDTH DIRECTION)	$F$	$3.50 \pm 0.05$	$0.138 \pm 0.002$
	CAVITY TO PERFORATION (LENGTH DIRECTION)	$P_2$	$2.00 \pm 0.05$	$0.079 \pm 0.002$

For product information and a complete list of distributors, please go to our web site: [www.avagotech.com](http://www.avagotech.com)

Avago, Avago Technologies, and the A logo are trademarks of Avago Technologies in the United States and other countries. Data subject to change. Copyright © 2005-2012 Avago Technologies. All rights reserved. Obsoletes 5989-3749EN AV02-0672EN - June 8, 2012

**AVAGO**  
TECHNOLOGIES

# Mouser Electronics

Authorized Distributor

Click to View Pricing, Inventory, Delivery & Lifecycle Information:

[Avago Technologies:](#)

[ATF-58143-BLKG](#) [ATF-58143-TR1G](#) [ATF-58143-TR2G](#)